

15 Displacements	(2.2 – 24.0 in ³ /rev)	
15 Schluckvolumen	36 . . . 390 cm ³ /rev	
15 Cylindrée		
15 Desplazamientos		
	Cont	Int
Maximum Pressure	(1800 psid)	(2400 psid)
Eingangsdruck	. . . 125 bar	. . . 165 bar
Chaute de pression max.		
Presion Maxima		
Maximum Oil Flow	(15 gpm)	
Schluckstrom	. . . 57 lpm	
Débit d'huile		
Caudal Maximo de Aceite		
Maximum Speed	(932 rpm)	
Drehzahl	932 rpm	
Vitesse de rotation		
Velocidad Maxima		
	Cont	Int
Maximum Torque	(3897 lb in)	(4783 lb in)
Max Drehmoment	440 Nm	540 Nm
Couple Maxi		
Torque Maximo		
Maximum Side Load at Key	(1100 lb)	
Seitenlast	. . . 4900 N	
Charges latérales		
Carga Maxima Lateral		

A Light to Medium Duty Low Speed, High Torque Motor

This light to medium duty motor incorporates all the features of heavy duty motors. Design features include a high pressure shaft seal so external drains are never required, roller vane technology for automatic wear compensation, and full flow internal cooling and flushing. This is a very economical motor for most light to medium duty applications.

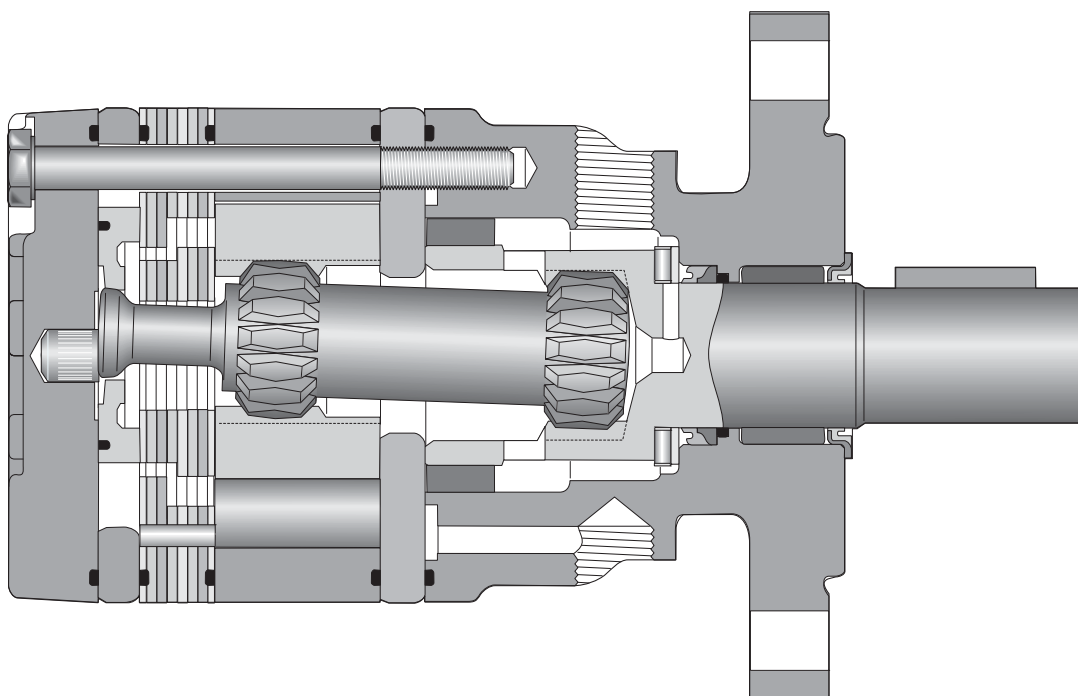

TB

Series



XXXX

Displacement
Schluckvolumen
Cylindrée
Desplazamiento

Code	cm ³ /U cm ³ /tr cm ³ /giro	in ³ /rev
0036	36 / 2.2	
0045	41 / 2.5	
0050	49 / 3.0	
0065	65 / 4.0	
0080	82 / 5.0	
0100	98 / 6.0	
0130	130 / 8.0	
0165	163 / 10.0	
0195	195 / 11.9	
0230	228 / 13.9	
0260	260 / 15.9	
0295	293 / 17.9	
0330	328 / 20.0	
0365	370 / 22.6	
0390	392 / 24.0	



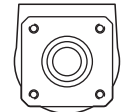

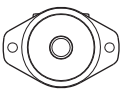
X

Mounting
Gehäuse
Carter
Montaje

Code	Mounting
A	SAE "A" 2 Bolt 
F	4 Bolt w/3/8-16 UNC 
M	Magneto 
C	SAE "A" 2 Bolt, Long Pilot 
B	SAE "B" 2 Bolt 

X

Ports
Anschluß
Plan de raccordement
Lumbreras

Code	Ports
M	5/16-18 UNC Manifold 
P	1/2-14 NPTF 
S	7/8-14 SAE 
W	G 1/2 BSPP 



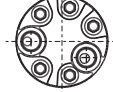
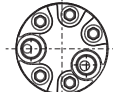





Rear Ports
Endanschluß
Alimentazione Laterale
Orifices arriér

Code	Rear Ports
R	3/4-16 SAE O-ring Axial 
Y	G 1/2 BSPP Axial 

For other available options, see pages 102–103.

XX



Shaft
Welle
Arbre
Eje

Code	Shaft
09	1" Straight w/0.38" Crosshole 
10	1" Keyed 
11	1" 6B Spline 
13	Long 1" Keyed 
21	1" Keyed; Corrosion Resistant 
25	1" Tapered 
26	25mm Keyed w/ 8mm Key 
28	7/8" 13 Tooth Spline 
59*	7/8" 13 Tooth Spline SAE 

* Conforms to SAE B recommended length

0

Rotation
Drehrichtung
Direction de rotation
Rotacion

Code	Rotation
0	Standard 
1	Reverse Timed Manifold 

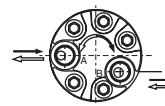
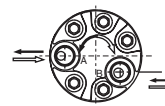
Code	Rear Port Rotation
0	Standard 
1	Reverse Timed Manifold 

Rotation viewed from shaft end.

XXXX

Options
Opciones

Code	Options
AAAA	Black Paint
AAAB	No Paint
AAAC	Double Paint
AAAF	Castle Nut, Black Paint
AABP	Castle Nut, No Paint
AAAG	Fluorocarbon Seals, Black Paint
AAAH	Fluorocarbon Seals, No Paint
AAAJ	High Temperature Commutator Seal, Black Paint
AAFG	High Temperature Commutator Seal, No Paint
AABJ*	Free Running Rotorset, Black Paint
AABK*	Free Running Rotorset, No Paint

*Not applicable to TB0365 or TB0390 displacements

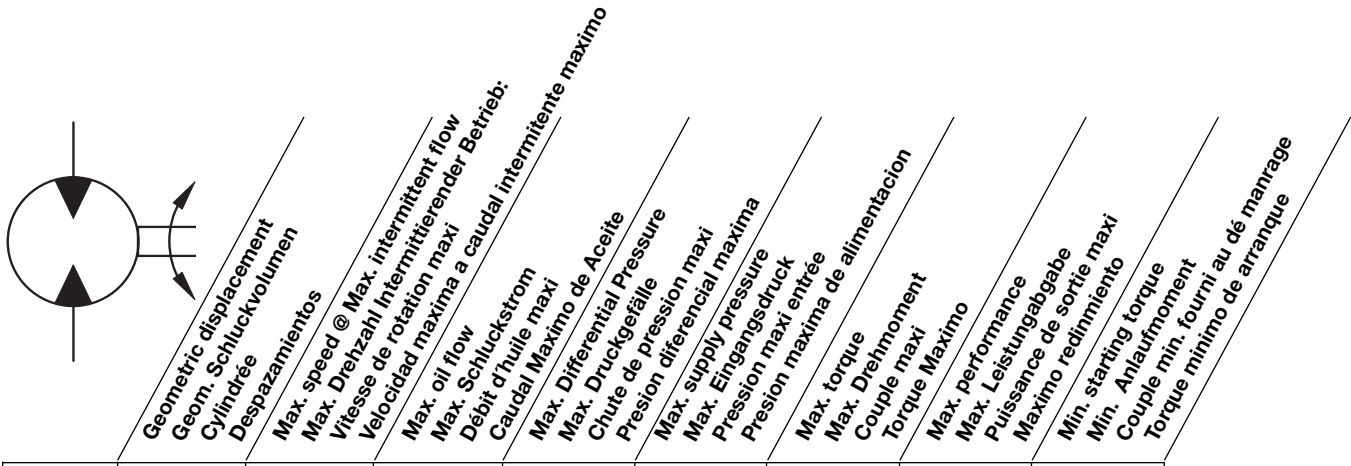

Motor Series TB	cm ³ /rev in ³ /rev	rev/min	cont / int* l/min g/min		cont / int* bar psid		max bar psig	cont / int* Nm lb-in		max KW HP	cont / int* Nm lb-in	
TB 0036	36 2.2	932	34 9	34 9	125 1800	165 2400	190 2750	48 427	67 596	6.6 8.8	44 385	50 440
TB 0045	41 2.5	805	34 9	34 9	125 1800	165 2400	190 2750	64 526	88 731	7.2 9.7	39 341	52 461
TB 0050	49 3.0	678	34 9	34 9	125 1800	165 2400	190 2750	78 693	107 946	7.5 10.1	36 319	70 619
TB 0065	65 4.0	511	34 9	34 9	125 1800	165 2400	190 2750	107 946	145 1284	7.8 10.4	66 582	99 977
TB 0080	82 5.0	409	34 9	34 9	125 1800	165 2400	190 2750	135 1193	184 1624	7.8 10.5	92 816	139 1226
TB 0100	98 6.0	454	45 12	45 12	125 1800	165 2400	190 2750	159 1411	217 1917	10.2 13.8	119 1050	158 1400
TB 0130	130 8.0	430	45 12	57 15	125 1800	165 2400	190 2750	220 1951	297 2632	13.4 18.0	167 1482	229 2024
TB 0165	163 10.0	343	45 12	57 15	125 1800	155 2250	190 2750	273 2418	346 3062	12.4 16.7	199 1760	263 2331
TB 0195	195 11.9	287	45 12	57 15	125 1800	145 2100	190 2750	340 3011	400 3537	12.0 16.1	270 2388	325 2872
TB 0230	228 13.9	246	45 12	57 15	103 1500	138 2000	190 2750	316 2797	427 3782	11.0 14.8	261 2354	353 3121
TB 0260	260 15.9	216	45 12	57 15	100 1450	131 1900	190 2750	350 3096	465 4117	10.5 14.1	291 2573	395 3498
TB 0295	293 17.9	191	45 12	57 15	97 1400	125 1800	190 2750	383 3391	499 4415	10.0 13.4	308 2724	400 3544
TB 0330	328 20.0	171	45 12	57 15	93 1350	114 1650	190 2750	413 3657	509 4505	9.1 12.2	332 2942	406 3590
TB 0365	370 22.6	151	45 12	57 15	86 1250	105 1525	190 2750	440 3897	540 4783	8.7 11.6	372 3296	454 4021
TB 0390	392 24.0	143	45 12	57 15	83 1200	100 1450	190 2750	428 3792	525 4642	7.8 10.5	339 3003	434 3845

Performance data based on testing using 10W40 oil with a viscosity of 43.1 cSt. (200 SUS) at 54° C (130° F). Performance data is typical. Actual data may vary slightly from one production motor to another.

Les donnees sur les performances sont basees sur des tests utilisant de l'huile 10W40 d'une viscosite de 200 SUS a 54°C (130°F). Ces donnees correspondent a des situations typiques. Les donnees reelles peuvent varier legerement d'un moteur de production a l'autre.

Leistungsdaten sind gemessen mit SAE 10W40 bei einer Viskosität von 43,1 Cst bei 54°C. Geringfügige Abweichungen von den Katalogdaten sind möglich.

Datos tecnicos obtenidos con aceite 10W40 de 200 SUS de viscosidad a 54°C (130°F). Los datos proporcionados son valores tipicos. Los valores exactos reales podrian tener una pequena variacion entre distintos motores.

* Intermittent operation rating applies to 10% of every minute.

Intermittierende Werte maximal 10% von jeder Betriebsminute.

Fonctionnement interm. 10% max. de chaque minute d'utilisation.

Capacidad de funcionamiento intermitente valida para 10% por cada minuto.

TB 0036

2.2 cu in / rev PRESSURE (PSID)

	500	1000	1500	1800	2000	2400
.5	108 45	223 37	343 26	418 19	468 15	570 8
1	114 97	234 88	357 77	431 70	481 66	581 57
2	112 202	235 191	361 179	440 172	492 168	598 158
3	113 307	241 295	370 282	450 274	503 269	610 258
4	109 411	241 398	373 384	455 376	509 370	620 358
5	104 515	237 501	371 486	453 477	509 471	621 459
7	87 724	225 708	360 691	443 681	498 674	613 660
9	71 932	208 915	344 896	427 884	483 876	598 860

Flow (GPM)

TORQUE (LB IN) 427
SPEED (RPM) 884

36 cc / rev

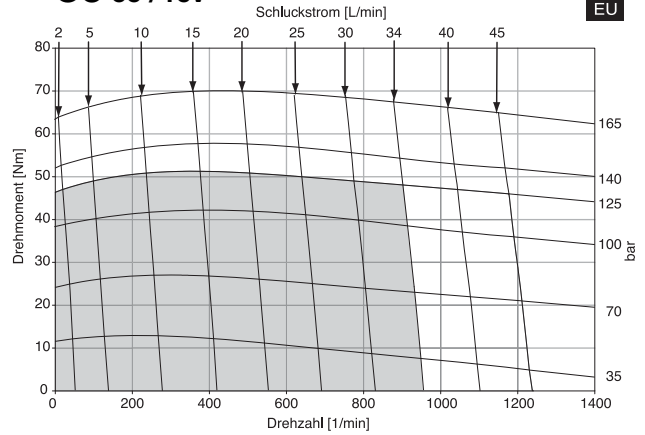

TB 0045

2.5 cu in / rev PRESSURE (PSID)

	500	1000	1500	1800	2000	2400
.5	116 31	263 17				
1	124 76	276 61	427 43	518 36	579 29	706 18
2	134 167	294 149	453 131	547 121	609 113	723 97
3	132 256	293 239	455 220	553 210	617 200	746 183
4	132 344	296 326	465 307	567 295	635 285	769 268
5	128 433	294 414	465 393	569 380	639 370	779 352
7	117 609	284 589	458 566	564 551	635 540	779 520
9	107 785	275 764	449 739	555 722	627 710	770 689

Flow (GPM)

TORQUE (LB IN) 555
SPEED (RPM) 722

41 cc / rev

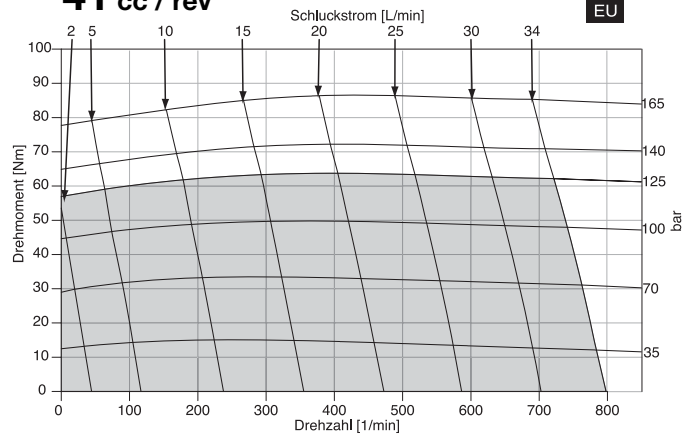

■ Cont. □ Int.

Intermittent operation rating applies to 10% of every minute.
Fonctionnement intermitt. 10% max. de chaque minute d'utilisation.
Performance data based on testing using 10W40 oil with a viscosity of 200 SUS at 54° C (130° F). Performance data is typical. Actual data may vary slightly from one production motor to another.
Les données sur les performances sont basées sur des tests utilisant de l'huile 10W40 d'une viscosité de 200 SUS à 54°C (130°F). Ces données correspondent à des situations typiques. Les données réelles peuvent varier légèrement d'un moteur de production à l'autre.

Intermittierende Werte maximal 10% von jeder Betriebsminute.
Capacidad de funcionamiento intermitente valida para 6 segundos por cada minuto.
Leistungsdaten sind gemessen mit SAE 10W40 bei einer Viskosität von 43,1 Cst bei 54°C. Geringfügige Abweichungen von den Katalogdaten sind möglich.
Datos tecnicos obtenidos con aceite 10W40 de 200 SUS de viscosidad a 54°C (130°F). Los datos proporcionados son valores tipicos. Los valores exactos reales podrian tener una pequena variacion entre distintos motores.

TB 0050

3.0 cu in / rev PRESSURE (PSID)

	500	1000	1500	1800	2000	2400
.5	144 26	319 13				
1	154 65	338 50	518 35	625 28	697 21	840 9
2	163 141	360 127	555 110	671 102	746 94	875 80
3	161 218	358 203	557 186	675 177	753 169	907 153
4	160 295	361 279	567 261	691 251	774 243	931 227
5	155 371	358 355	566 337	693 326	777 317	946 301
7	143 525	346 507	558 487	686 474	772 466	946 448
9	133 678	336 658	546 638	675 623	761 614	936 595

Flow (GPM)

TORQUE (LB IN) 675
SPEED (RPM) 623

49 cc / rev

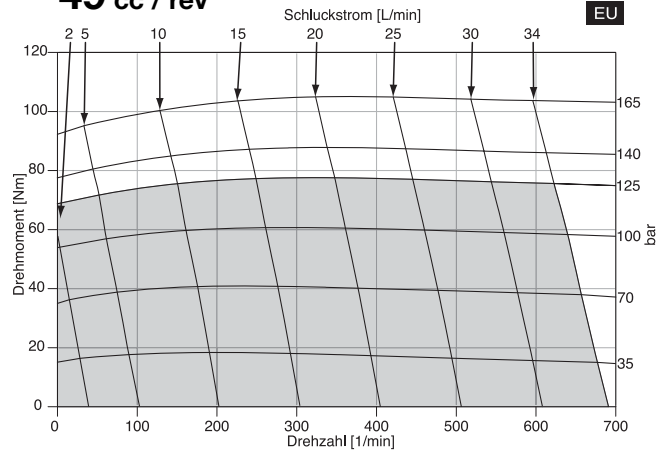

TB 0065

4.0 cu in / rev PRESSURE (PSID)

	500	1000	1500	1800	2000	2400
.5	213 22	459 14	709 6			
1	224 51	479 42	734 34	887 29	989 25	1193 17
2	233 108	500 99	767 90	926 85	1033 81	1228 71
3	231 166	498 156	769 147	932 141	1039 136	1252 126
4	229 224	501 214	778 203	945 197	1056 192	1272 181
5	223 281	497 271	777 260	946 252	1058 247	1284 237
7	206 396	481 385	764 372	936 364	1050 359	1280 347
9	192 511	467 499	749 485	920 476	1035 470	1267 457

Flow (GPM)

TORQUE (LB IN) 920
SPEED (RPM) 476

65 cc / rev

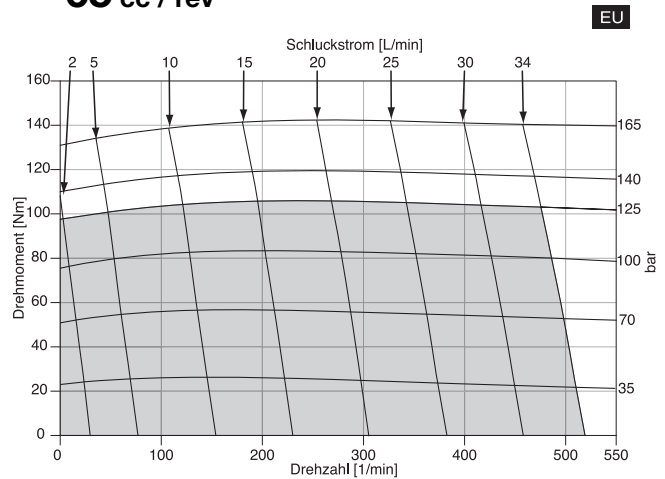

■ Cont. □ Int.

Intermittent operation rating applies to 10% of every minute.

Fonctionnement interm. 10% max. de chaque minute d'utilisation.

Performance data based on testing using 10W40 oil with a viscosity of 200 SUS at 54° C (130° F). Performance data is typical. Actual data may vary slightly from one production motor to another.

Les données sur les performances sont basées sur des tests utilisant de l'huile 10W40 d'une viscosité de 200 SUS à 54°C (130°F). Ces données correspondent à des situations typiques. Les données réelles peuvent varier légèrement d'un moteur de production à l'autre.

Intermittierende Werte maximal 10% von jeder Betriebsminute.

Capacidad de funcionamiento intermitente valida para 6 segundos por cada minuto.

Leistungsdaten sind gemessen mit SAE 10W40 bei einer Viskosität von 43,1 Cst bei 54°C. Geringfügige Abweichungen von den Katalogdaten sind möglich.

Datos tecnicos obtenidos con aceite 10W40 de 200 SUS de viscosidad a 54°C (130°F). Los datos proporcionados son valores tipicos. Los valores exactos reales podrian tener una pequena variacion entre distintos motores.

TB 0080

5.0 cu in / rev PRESSURE (PSID)

	500	1000	1500	1800	2000	2400
.5	256 17	562 10	877 4			
1	269 40	585 33	905 26	1097 21	1226 18	1487 10
2	285 86	616 78	950 70	1150 66	1283 62	1527 53
3	285 132	619 124	959 116	1163 110	1298 106	1566 97
4	286 178	628 170	976 161	1187 155	1327 151	1600 141
5	282 225	627 216	979 206	1193 200	1335 196	1621 185
7	267 317	615 307	972 296	1189 290	1333 285	1624 274
9	252 409	600 398	956 387	1173 379	1318 374	1609 362

Flow (GPM)

TORQUE (LB IN) 1173
SPEED (RPM) 379

82 cc / rev

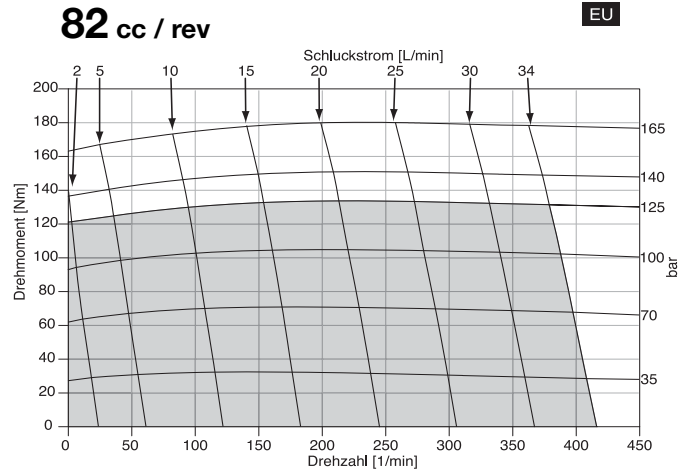

EU

TB 0100

6.0 cu in / rev PRESSURE (PSID)

	500	1000	1500	1800	2000	2400
.5	310 16	669 13	1035 9	1258 7	1408 5	
1	330 35	697 32	1073 27	1298 25	1448 23	1737 18
2	346 73	732 69	1121 64	1353 61	1509 59	1800 53
3	345 111	735 107	1134 102	1371 98	1530 95	1844 89
4	347 149	747 144	1158 139	1403 135	1569 132	1885 126
5	343 187	750 182	1164 176	1411 172	1578 169	1909 162
7	327 264	738 257	1159 250	1411 246	1580 242	1917 235
9	301 340	715 333	1139 325	1395 319	1566 316	1909 307
12	257 454	669 446	1091 437	1347 430	1518 426	1863 417

Flow (GPM)

TORQUE (LB IN) 1347
SPEED (RPM) 430

98 cc / rev

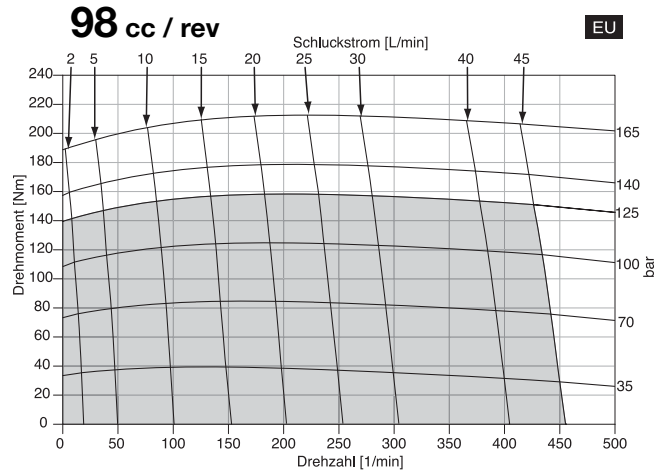

EU

■ Cont. □ Int.

Intermittent operation rating applies to 10% of every minute.

Fonctionnement intermitt. 10% max. de chaque minute d'utilisation.

Performance data based on testing using 10W40 oil with a viscosity of 200 SUS at 54° C (130° F). Performance data is typical. Actual data may vary slightly from one production motor to another.

Les données sur les performances sont basées sur des tests utilisant de l'huile 10W40 d'une viscosité de 200 SUS à 54°C (130°F). Ces données correspondent à des situations typiques. Les données réelles peuvent varier légèrement d'un moteur de production à l'autre.

Intermittierende Werte maximal 10% von jeder Betriebsminute.

Capacidad de funcionamiento intermitente valida para 6 segundos por cada minuto.

Leistungsdaten sind gemessen mit SAE 10W40 bei einer Viskosität von 43,1 Cst bei 54°C. Geringfügige Abweichungen von den Katalogdaten sind möglich.

Datos tecnicos obtenidos con aceite 10W40 de 200 SUS de viscosidad a 54°C (130°F). Los datos proporcionados son valores típicos. Los valores exactos reales podrían tener una pequeña variación entre distintos motores.

TB 0130

8.0 cu in / rev PRESSURE (PSID)

	500	1000	1500	1800	2000	2400
.5	446 12	955 10	1479 7	1797 5	2011 3	
1	465 27	989 24	1515 21	1831 19	2043 17	2469 13
2	481 55	1023 52	1571 49	1901 46	2120 44	2520 40
3	482 84	1029 81	1581 77	1912 74	2133 72	2570 67
4	483 113	1042 109	1605 105	1940 102	2164 100	2608 95
5	478 142	1041 138	1610 133	1951 130	2179 128	2628 122
7	450 199	1019 195	1597 190	1943 186	2174 184	2632 177
9	414 257	984 252	1563 246	1911 242	2145 239	2612 233
12	335 343	907 338	1489 331	1842 327	2076 323	2550 316
15	253 430	818 424	1393 416	1740 411	1974 407	2443 399

Flow (GPM)

TORQUE (LB IN) 2612
SPEED (RPM) 233

130 cc / rev

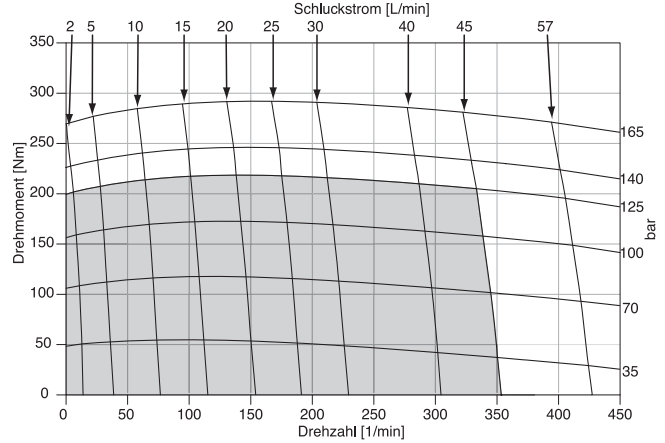

TB 0165

10.0 cu in / rev PRESSURE (PSID)

	500	1000	1500	1800	2250
.5	529 9	1137 7	1769 4	2149 3	
1	556 21	1181 18	1819 15	2201 13	2776 9
2	580 44	1238 40	1909 37	2314 34	2876 29
3	584 67	1248 63	1926 59	2332 56	2934 51
4	592 90	1276 86	1968 82	2382 78	3000 73
5	588 113	1283 109	1988 104	2412 101	3046 95
7	560 159	1268 154	1987 149	2418 145	3062 139
9	517 205	1230 200	1957 194	2393 190	3047 183
12	425 274	1141 268	1874 262	2317 257	2980 250
15	321 343	1033 337	1759 330	2197 325	2859 317

Flow (GPM)

TORQUE (LB IN) 3047
SPEED (RPM) 183

163 cc / rev

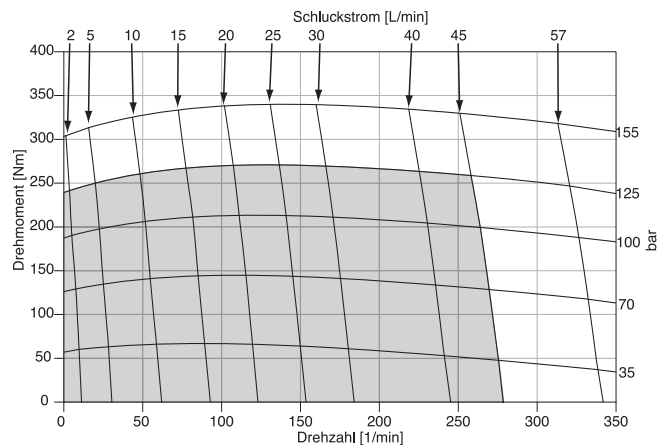

Intermittent operation rating applies to 10% of every minute.

Fonctionnement interm. 10% max. de chaque minute d'utilisation.

Performance data based on testing using 10W40 oil with a viscosity of 200 SUS at 54° C (130° F). Performance data is typical. Actual data may vary slightly from one production motor to another.

Les donnees sur les performances sont basees sur des tests utilisant de l'huile 10W40 d'une viscosite de 200 SUS a 54°C (130°F). Ces donnees correspondent a des situations typiques. Les donnees reelles peuvent varier legerement d'un moteur de production a l'autre.

Intermittierende Werte maximal 10% von jeder Betriebsminute.

Capacidad de funcionamiento intermitente valida para 6 segundos por cada minuto.

Leistungsdaten sind gemessen mit SAE 10W40 bei einer Viskosität von 43,1 Cst bei 54°C. Geringfügige Abweichungen von den Katalogdaten sind möglich.

Datos tecnicos obtenidos con aceite 10W40 de 200 SUS de viscosidad a 54°C (130°F). Los datos proporcionados son valores tipicos. Los valores exactos reales podrian tener una pequena variacion entre distintos motores.

TB 0195

11.9 cu in / rev PRESSURE (PSID)

	500	1000	1500	1800	2100
.5	688 9	1490 8	2329 7	2841 6	3353 5
1	718 18	1537 17	2380 16	2890 15	3373 14
2	746 38	1580 36	2443 35	2962 33	3442 32
3	745 57	1592 55	2452 53	2973 52	3494 50
4	746 76	1607 74	2482 72	3008 71	3528 69
5	737 95	1601 93	2480 91	3011 89	3537 87
7	697 134	1572 131	2455 129	2986 127	3514 125
9	641 172	1510 169	2398 167	2934 164	3472 162
12	530 230	1391 227	2283 223	2821 221	3360 217
15	399 287	1252 284	2130 280	2662 277	3200 273

Flow (GPM)

TORQUE (LB IN) 3472
SPEED (RPM) 162

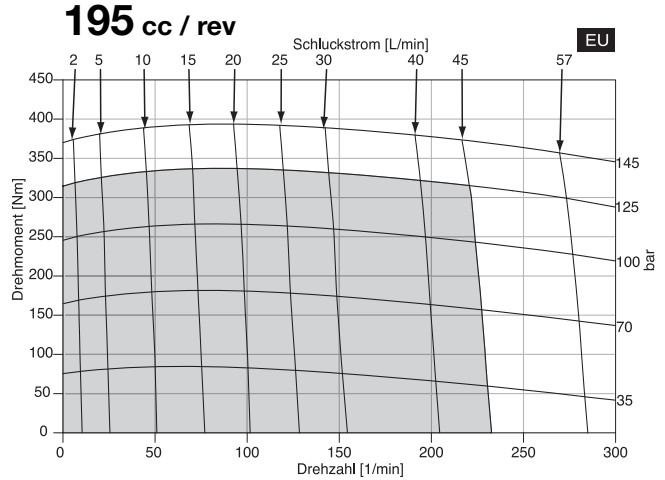

TB 0230

13.9 cu in / rev PRESSURE (PSID)

	500	1000	1500	2000
.5	796 8	1704 7	2640 6	3597 5
1	818 16	1733 15	2681 14	3623 13
2	840 32	1775 31	2732 30	3700 28
3	845 49	1789 47	2750 46	3725 43
4	848 65	1815 64	2789 62	3762 59
5	840 82	1813 80	2797 78	3782 74
7	799 114	1790 112	2785 110	3776 106
9	741 147	1738 145	2738 142	3741 138
12	613 197	1615 194	2626 190	3645 185
15	473 246	1531 243	2457 239	3467 233

Flow (GPM)

TORQUE (LB IN) 3776
SPEED (RPM) 106

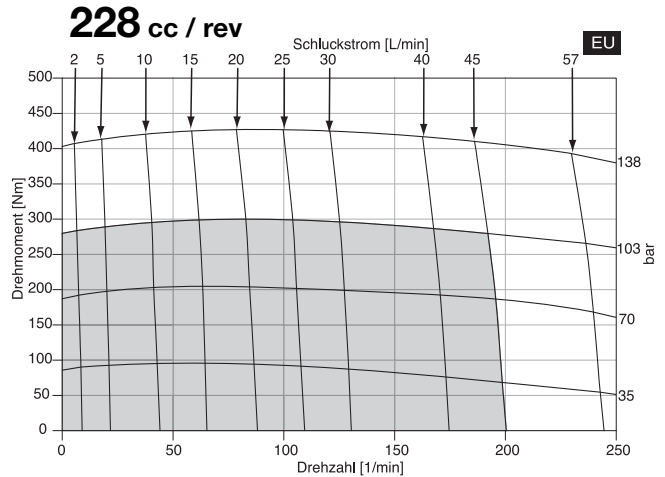

Cont. Int.

Intermittent operation rating applies to 10% of every minute.
Fonctionnement interm. 10% max. de chaque minute d'utilisation.
Performance data based on testing using 10W40 oil with a viscosity of 200 SUS at 54° C (130° F). Performance data is typical. Actual data may vary slightly from one production motor to another.
Les donnees sur les performances sont basees sur des tests utilisant de l'huile 10W40 d'une viscosite de 200 SUS a 54°C (130°F). Ces donnees correspondent a des situations typiques. Les donnees reelles peuvent varier legerement d'un moteur de production a l'autre.

Intermittierende Werte maximal 10% von jeder Betriebsminute.
Capacidad de funcionamiento intermitente valida para 6 segundos por cada minuto.
Leistungsdaten sind gemessen mit SAE 10W40 bei einer Viskositat von 43,1 Cst bei 54°C. Geringfuegige Abweichungen von den Katalogdaten sind moeglich.
Datos tecnicos obtenidos con aceite 10W40 de 200 SUS de viscosidad a 54°C (130°F). Los datos proporcionados son valores tipicos. Los valores exactos reales podrian tener una pequena variacion entre distintos motores.

TB 0260

15.9 cu in / rev PRESSURE (PSID)

	500	1000	1450	1900
.5	906 7	1947 6	2910 5	3896 4
1	932 14	1984 13	2964 12	3919 11
2	958 28	2032 27	3025 26	4000 24
3	961 43	2047 41	3045 40	4052 38
4	963 57	2074 56	3086 54	4098 52
5	954 71	2074 70	3096 68	4117 65
7	909 100	2049 99	3084 96	4112 93
9	844 129	1991 127	3032 125	4070 121
12	696 172	1851 170	2903 167	3953 162
15	540 216	1683 213	2711 209	3753 204

TORQUE (LB IN) 4112
SPEED (RPM) 93

Flow (GPM)

TB 0295

17.9 cu in / rev PRESSURE (PSID)

	500	1000	1400	1800
.5	1039 6	2229 5	3208 4	4200 3
1	1069 12	2281 11	3265 10	4248 9
2	1098 25	2332 24	3337 22	4290 20
3	1100 38	2344 36	3353 35	4356 32
4	1098 50	2366 49	3386 47	4398 44
5	1086 63	2361 61	3391 60	4415 57
7	1034 89	2325 87	3361 85	4394 81
9	955 114	2250 112	3295 109	4337 106
12	792 153	2085 150	3141 147	4194 142
15	606 191	1879 188	2908 185	3955 180

TORQUE (LB IN) 4337
SPEED (RPM) 106

Flow (GPM)

260 cc / rev

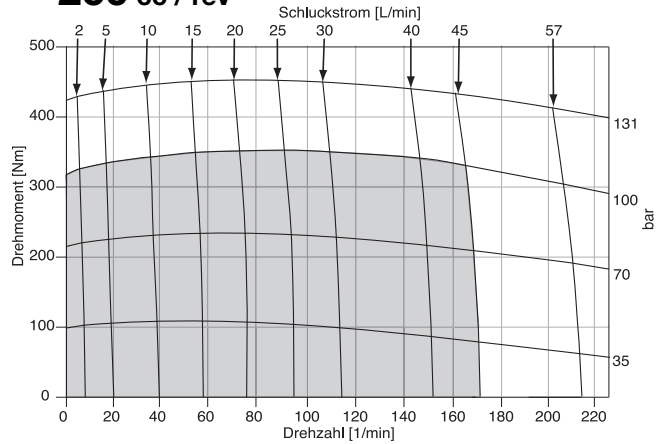

293 cc / rev

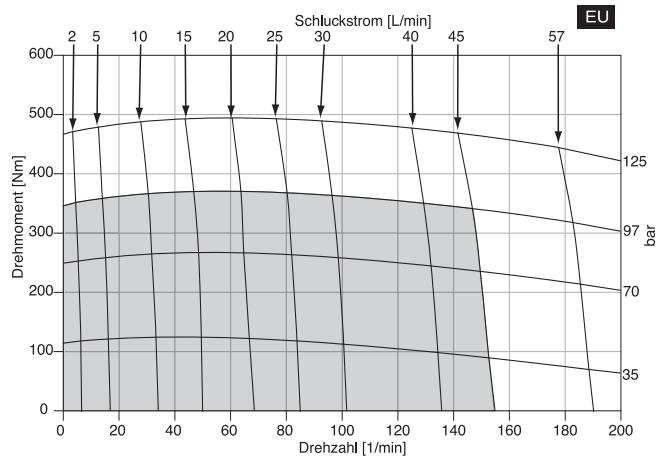

■ Cont. □ Int.

Intermittent operation rating applies to 10% of every minute.

Fonctionnement interm. 10% max. de chaque minute d'utilisation.

Performance data based on testing using 10W40 oil with a viscosity of 200 SUS at 54° C (130° F). Performance data is typical. Actual data may vary slightly from one production motor to another.

Les données sur les performances sont basées sur des tests utilisant de l'huile 10W40 d'une viscosité de 200 SUS à 54°C (130°F). Ces données correspondent à des situations typiques. Les données réelles peuvent varier légèrement d'un moteur de production à l'autre.

Intermittierende Werte maximal 10% von jeder Betriebsminute.

Capacidad de funcionamiento intermitente valida para 6 segundos por cada minuto.

Leistungsdaten sind gemessen mit SAE 10W40 bei einer Viskosität von 43,1 Cst bei 54°C. Geringfügige Abweichungen von den Katalogdaten sind möglich.

Datos tecnicos obtenidos con aceite 10W40 de 200 SUS de viscosidad a 54°C (130°F). Los datos proporcionados son valores típicos. Los valores exactos reales podrian tener una pequeña variacion entre distintos motores.

TB 0330

20.0 cu in / rev PRESSURE (PSID)

	500	1000	1350	1650
.5	1192 5	2498 4	3425 4	4227 3
1	1224 11	2555 10	3495 9	4250 8
2	1255 22	2620 21	3581 20	4350 18
3	1259 34	2633 32	3597 31	4424 29
4	1258 45	2666 43	3645 42	4480 40
5	1243 56	2665 55	3657 53	4505 51
7	1186 79	2627 77	3634 75	4492 73
9	1092 102	2544 100	3563 97	4431 94
12	905 137	2363 134	3391 131	4269 127
15	692 171	2129 168	3136 165	4001 161

Flow (GPM)

TORQUE (LB IN) 4431
SPEED (RPM) 94

328 cc / rev

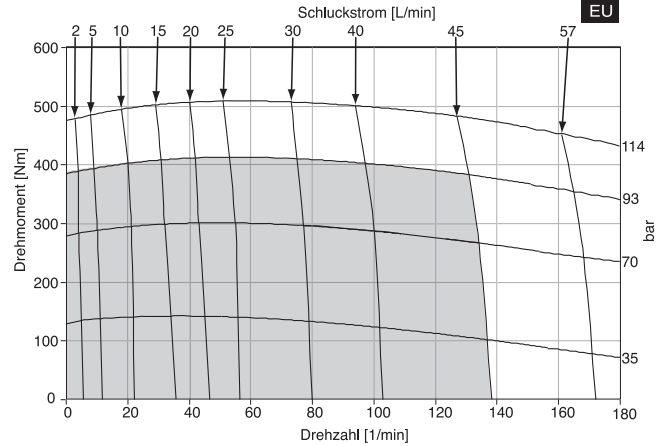

TB 0365

22.6 cu in / rev PRESSURE (PSID)

	500	1000	1250	1525
.5	1393 5	2942 4	3734 4	4617 3
1	1444 10	3005 9	3796 9	4672 8
2	1494 20	3090 19	3890 18	4710 17
3	1485 30	3082 29	3883 28	4765 27
4	1477 40	3089 39	3897 38	4783 36
5	1452 50	3075 49	3887 48	4775 46
7	1371 70	3009 69	3826 67	4719 65
9	1260 90	2899 89	3721 87	4621 85
12	1002 121	2658 119	3488 117	4393 115
15	700 151	2355 149	3190 147	4095 144

Flow (GPM)

TORQUE (LB IN) 4621
SPEED (RPM) 85

370 cc / rev

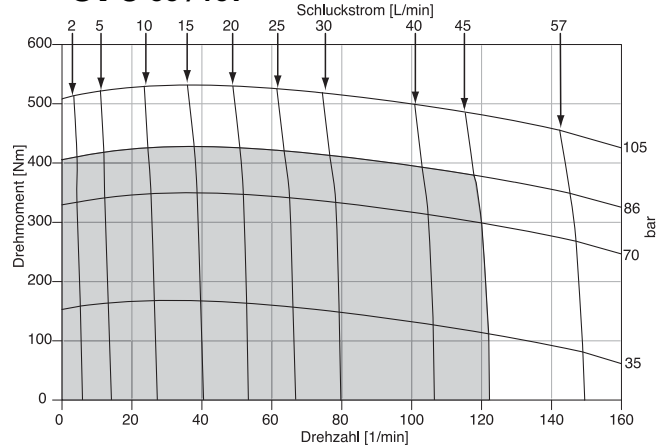

■ Cont. □ Int.

Intermittent operation rating applies to 10% of every minute.
Fonctionnement interm. 10% max. de chaque minute d'utilisation.
Performance data based on testing using 10W40 oil with a viscosity of 200 SUS at 54° C (130° F). Performance data is typical. Actual data may vary slightly from one production motor to another.
Les donnees sur les performances sont basees sur des tests utilisant de l'huile 10W40 d'une viscosite de 200 SUS a 54°C (130°F). Ces donnees correspondent a des situations typiques. Les donnees reelles peuvent varier legerement d'un moteur de production a l'autre.

Intermittierende Werte maximal 10% von jeder Betriebsminute.
Capacidad de funcionamiento intermitente valida para 6 segundos por cada minuto.
Leistungsdaten sind gemessen mit SAE 10W40 bei einer Viskositat von 43,1 Cst bei 54°C. Geringfuegige Abweichungen von den Katalogdaten sind moeglich.
Datos tecnicos obtenidos con aceite 10W40 de 200 SUS de viscosidad a 54°C (130°F). Los datos proporcionados son valores tipicos. Los valores exactos reales podrian tener una pequena variacion entre distintos motores.

TB 0390

24.0 cu in / rev PRESSURE (PSID)

	500	1000	1200	1450
.5	1309 4	2885 3	3534 2	4359 2
1	1368 9	2948 8	3589 7	4394 6
2	1417 18	3028 17	3683 16	4460 15
3	1427 28	3058 26	3714 26	4540 24
4	1443 37	3102 36	3764 35	4595 34
5	1439 47	3120 45	3790 45	4630 43
7	1392 66	3110 65	3792 64	4642 62
9	1297 85	3040 84	3732 83	4597 81
12	1087 114	2835 112	3541 111	4418 110
15	831 143	2571 141	3272 140	4145 138

Flow (GPM)

TORQUE (LB IN) 4597
SPEED (RPM) 81

392 cc / rev

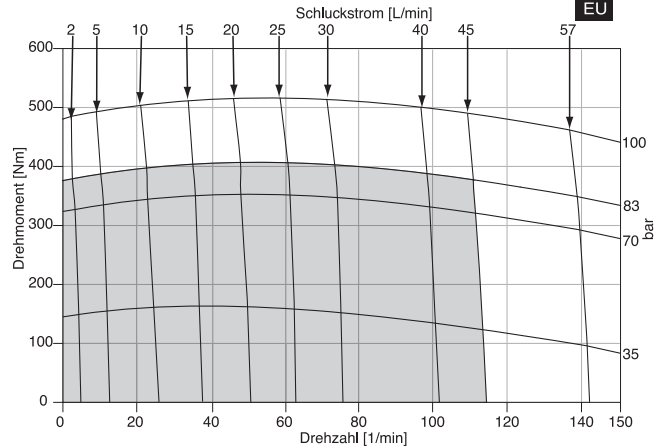

Cont. Int.

Intermittent operation rating applies to 10% of every minute.

Fonctionnement interm. 10% max. de chaque minute d'utilisation.

Performance data based on testing using 10W40 oil with a viscosity of 200 SUS at 54° C (130° F). Performance data is typical. Actual data may vary slightly from one production motor to another.

Les donnees sur les performances sont basees sur des tests utilisant de l'huile 10W40 d'une viscosite de 200 SUS a 54°C (130°F). Ces donnees correspondent a des situations typiques. Les donnees reelles peuvent varier legerement d'un moteur de production a l'autre.

Intermittierende Werte maximal 10% von jeder Betriebsminute.

Capacidad de funcionamiento intermitente valida para 6 segundos por cada minuto.

Leistungsdaten sind gemessen mit SAE 10W40 bei einer Viskosität von 43,1 Cst bei 54°C. Geringfügige Abweichungen von den Katalogdaten sind möglich.

Datos tecnicos obtenidos con aceite 10W40 de 200 SUS de viscosidad a 54°C (130°F). Los datos proporcionados son valores tipicos. Los valores exactos reales podrian tener una pequena variacion entre distintos motores.

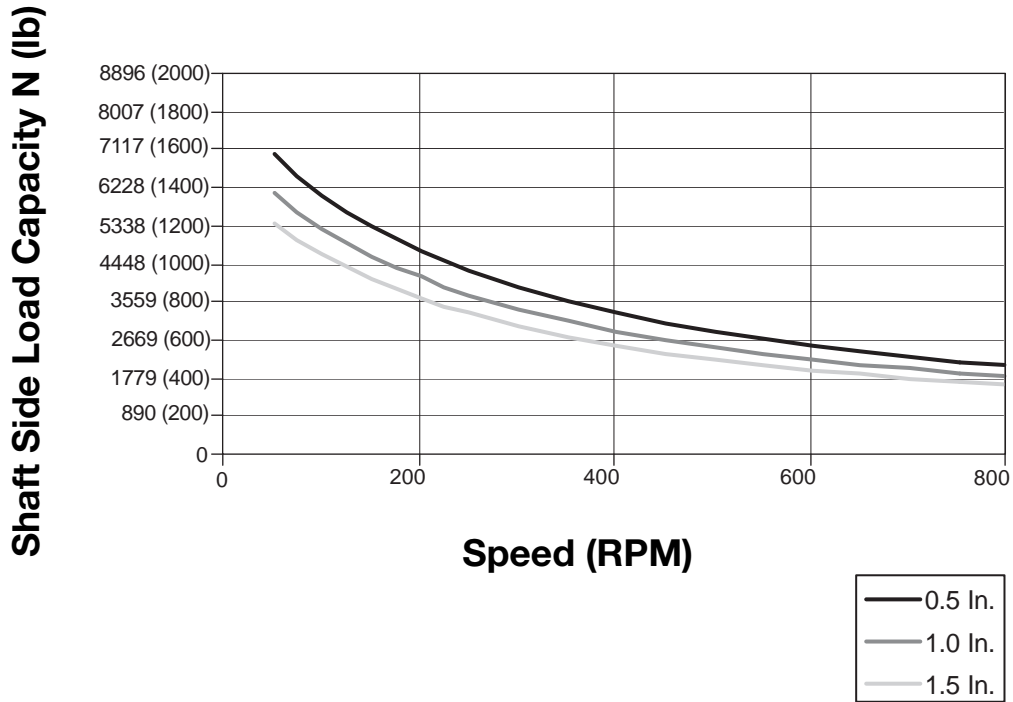

The allowable side load curve is based on bushing life of 2.5×10^6 revolutions.
 Die zulaessige radiale Wellenbelastung bezieht sich auf die Lager-Lebensdauer $2,5 \times 10^6$ Umdrehungen.
 L'effort radial admissible sur l'arbre depend a une duree de vie $2,5 \times 10^6$ de rotation.
 La curva de carga lateral admisible se basa en vida util de cojinete de 2.5×10^6 revoluciones.

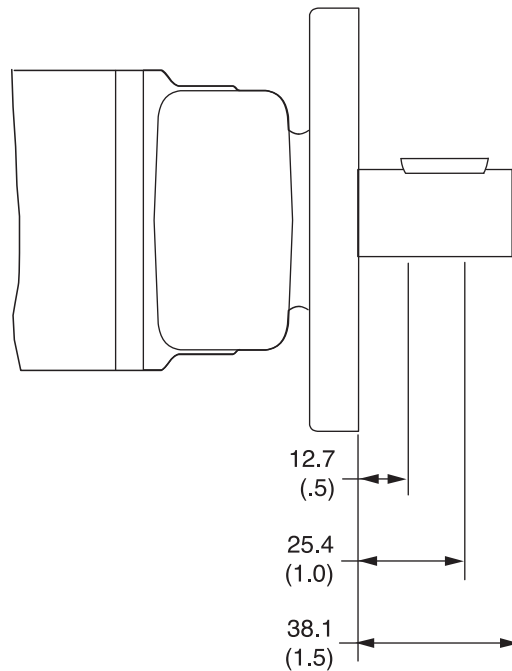

English equivalents for metric specifications are shown in ().

Code: AM

**SAE A 2-Bolt,
5/16-18 UNC
Manifold**

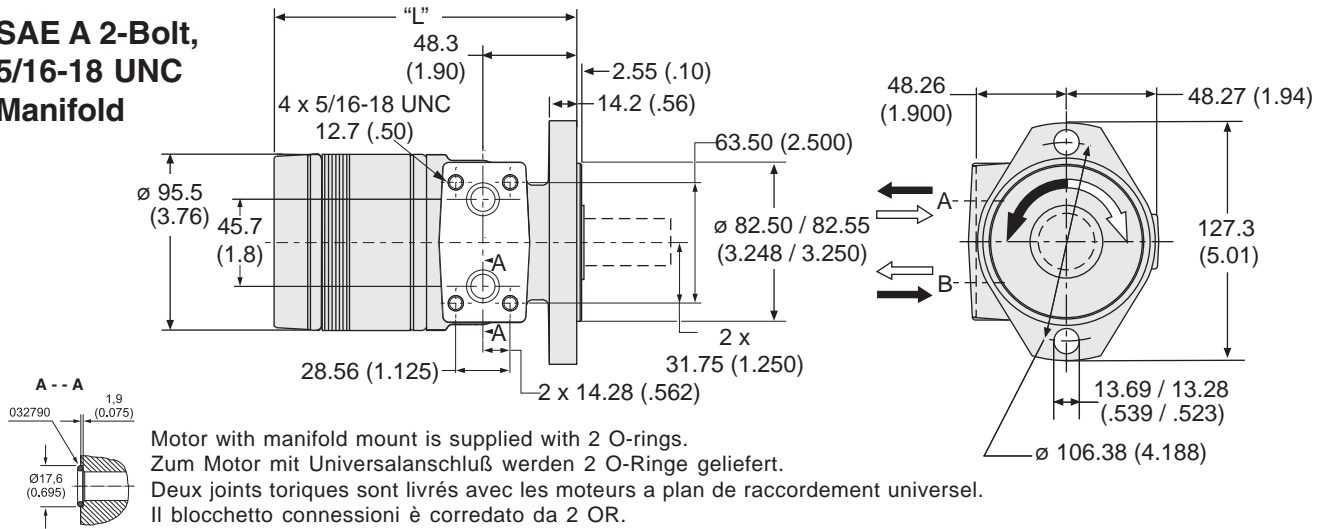

Code AM disp.	0036	0045	0050	0065	0080	0100	0130	0165	0195	0230	0260	0295	0330	0365	0390
Weight/Gewicht kg	5.87	6.03	6.12	6.26	6.35	6.49	6.76	7.03	7.35	7.58	7.80	8.07	8.35	8.66	8.80
Poids/Peso (lb)	(12.9)	(13.3)	(13.5)	(13.8)	(14.0)	(14.3)	(14.9)	(15.5)	(16.2)	(16.7)	(17.2)	(17.8)	(18.4)	(19.1)	(19.4)
Length "L" mm	132.4	136	138	141	144	147	154	160	166	173	179	185	192	200	205
"L" (in)	(5.22)	(5.36)	(5.42)	(5.54)	(5.67)	(5.79)	(6.04)	(6.29)	(6.54)	6.79	7.04	7.29	7.54	7.88	8.04

Code: AP

**SAE A 2-Bolt,
1/2-14 NPTF**

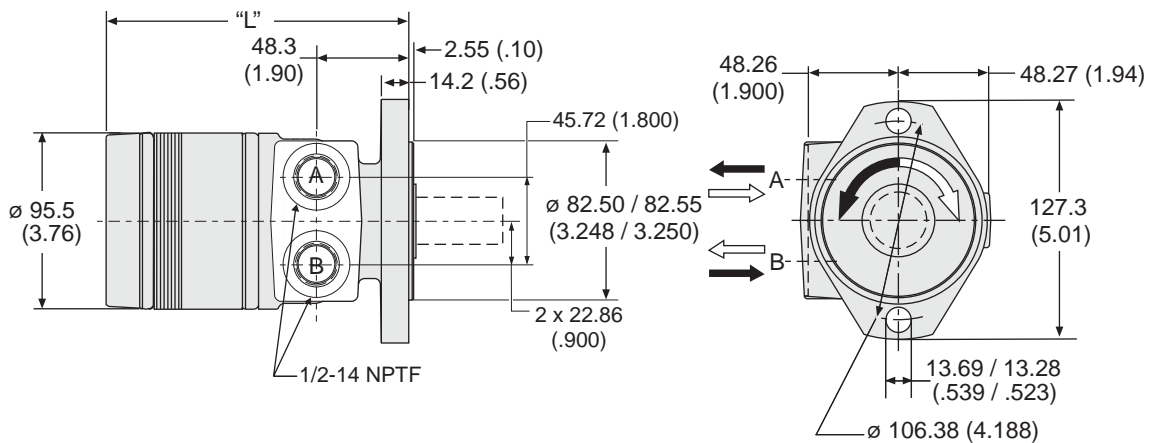

Code AP disp.	0036	0045	0050	0065	0080	0100	0130	0165	0195	0230	0260	0295	0330	0365	0390
Weight/Gewicht kg	5.87	6.03	6.12	6.26	6.35	6.49	6.76	7.03	7.35	7.58	7.80	8.07	8.35	8.66	8.80
Poids/Peso (lb)	(12.9)	(13.3)	(13.5)	(13.8)	(14.0)	(14.3)	(14.9)	(15.5)	(16.2)	(16.7)	(17.2)	(17.8)	(18.4)	(19.1)	(19.4)
Length "L" mm	132.4	136	138	141	144	147	154	160	166	173	179	185	192	200	205
"L" (in)	(5.22)	(5.36)	(5.42)	(5.54)	(5.67)	(5.79)	(6.04)	(6.29)	(6.54)	6.79	7.04	7.29	7.54	7.88	8.04

English equivalents for metric specifications are shown in ().

Code: AS

**SAE A 2-Bolt,
 7/8"-14 SAE
 O-Ring**

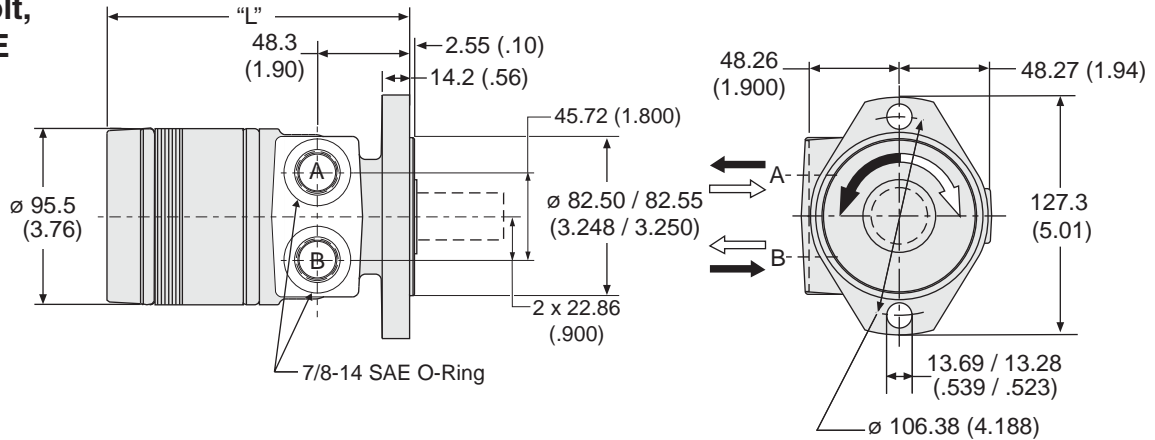

Code AS disp.	0036	0045	0050	0065	0080	0100	0130	0165	0195	0230	0260	0295	0330	0365	0390
Weight/Gewicht kg	5.87	6.03	6.12	6.26	6.35	6.49	6.76	7.03	7.35	7.58	7.80	8.07	8.35	8.66	8.80
Poids/Peso (lb)	(12.9)	(13.3)	(13.5)	(13.8)	(14.0)	(14.3)	(14.9)	(15.5)	(16.2)	(16.7)	(17.2)	(17.8)	(18.4)	(19.1)	(19.4)
Length "L" mm	132.4	136	138	141	144	147	154	160	166	173	179	185	192	200	205
"L" (in)	(5.22)	(5.36)	(5.42)	(5.54)	(5.67)	(5.79)	(6.04)	(6.29)	(6.54)	6.79	7.04	7.29	7.54	7.88	8.04

Code: FM

**4-Bolt,
 5/16-18 UNC
 Manifold**

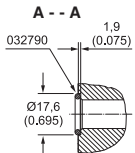
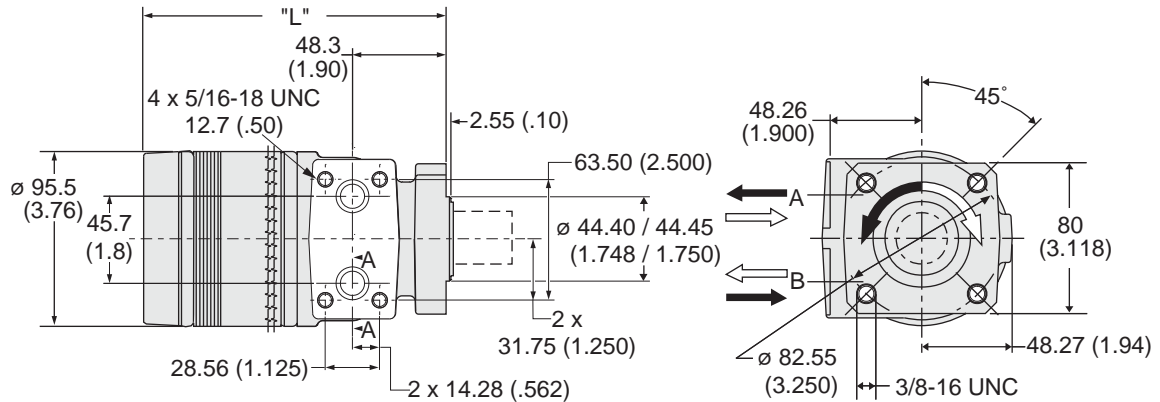

Motor with manifold mount is supplied with 2 O-rings.
 Zum Motor mit Universalanschlusß werden 2 O-Ringe geliefert.
 Deux joints toriques sont livrés avec les moteurs a plan de raccordement universel.
 Il blocchetto connessioni è corredato da 2 OR.

Code FM disp.	0036	0045	0050	0065	0080	0100	0130	0165	0195	0230	0260	0295	0330	0365	0390
Weight/Gewicht kg	5.58	5.62	5.67	5.80	5.94	6.08	6.31	6.62	7.03	7.17	7.39	7.62	7.94	8.26	8.39
Poids/Peso (lb)	(12.3)	(12.4)	(12.5)	(12.8)	(13.1)	(13.4)	(13.9)	(14.6)	(15.5)	(15.8)	(16.3)	(16.8)	(17.5)	(18.2)	(18.5)
Length "L" mm	132.4	136	138	141	144	147	154	160	166	173	179	185	192	200	205
"L" (in)	(5.22)	(5.36)	(5.42)	(5.54)	(5.67)	(5.79)	(6.04)	(6.29)	(6.54)	(6.79)	(7.04)	(7.29)	(7.54)	(7.88)	(8.04)

English equivalents for metric specifications are shown in ().

Code: FP

**4 Bolt,
1/2-14 NPTF**

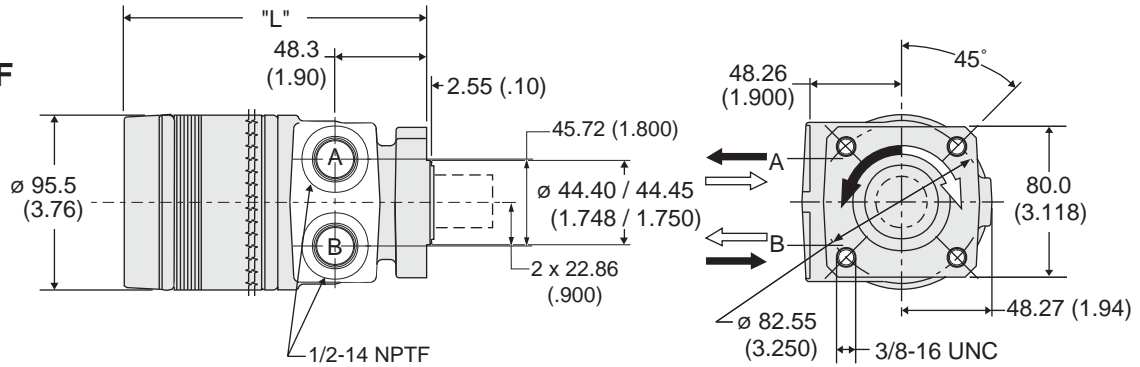

Code FP disp.	0036	0045	0050	0065	0080	0100	0130	0165	0195	0230	0260	0295	0330	0365	0390
Weight/Gewicht kg	5.58	5.62	5.67	5.80	5.94	6.08	6.31	6.62	7.03	7.17	7.39	7.62	7.94	8.26	8.39
Poids/Peso (lb)	(12.3)	(12.4)	(12.5)	(12.8)	(13.1)	(13.4)	(13.9)	(14.6)	(15.5)	(15.8)	(16.3)	(16.8)	(17.5)	(18.2)	(18.5)
Length "L" mm	132.4	136	138	141	144	147	154	160	166	173	179	185	192	200	205
"L" (in)	(5.22)	(5.36)	(5.42)	(5.54)	(5.67)	(5.79)	(6.04)	(6.29)	(6.54)	(6.79)	(7.04)	(7.29)	(7.54)	(7.88)	(8.04)

Code: FS

**4 Bolt,
7/8"-14 SAE
O-Ring**

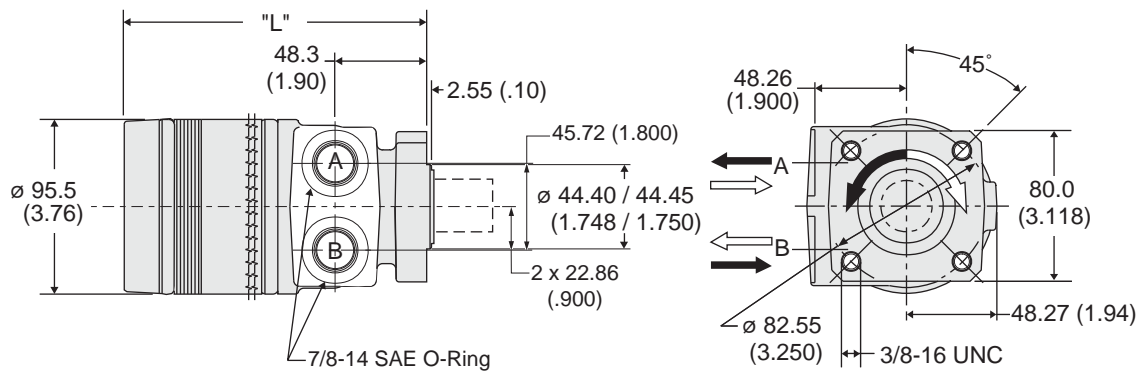

Code FS disp.	0036	0045	0050	0065	0080	0100	0130	0165	0195	0230	0260	0295	0330	0365	0390
Weight/Gewicht kg	5.58	5.62	5.67	5.80	5.94	6.08	6.31	6.62	7.03	7.17	7.39	7.62	7.94	8.26	8.39
Poids/Peso (lb)	(12.3)	(12.4)	(12.5)	(12.8)	(13.1)	(13.4)	(13.9)	(14.6)	(15.5)	(15.8)	(16.3)	(16.8)	(17.5)	(18.2)	(18.5)
Length "L" mm	132.4	136	138	141	144	147	154	160	166	173	179	185	192	200	205
"L" (in)	(5.22)	(5.36)	(5.42)	(5.54)	(5.67)	(5.79)	(6.04)	(6.29)	(6.54)	(6.79)	(7.04)	(7.29)	(7.54)	(7.88)	(8.04)

English equivalents for metric specifications are shown in ().

Code: BS
SAE B 2-Bolt
7/8-14 SAE

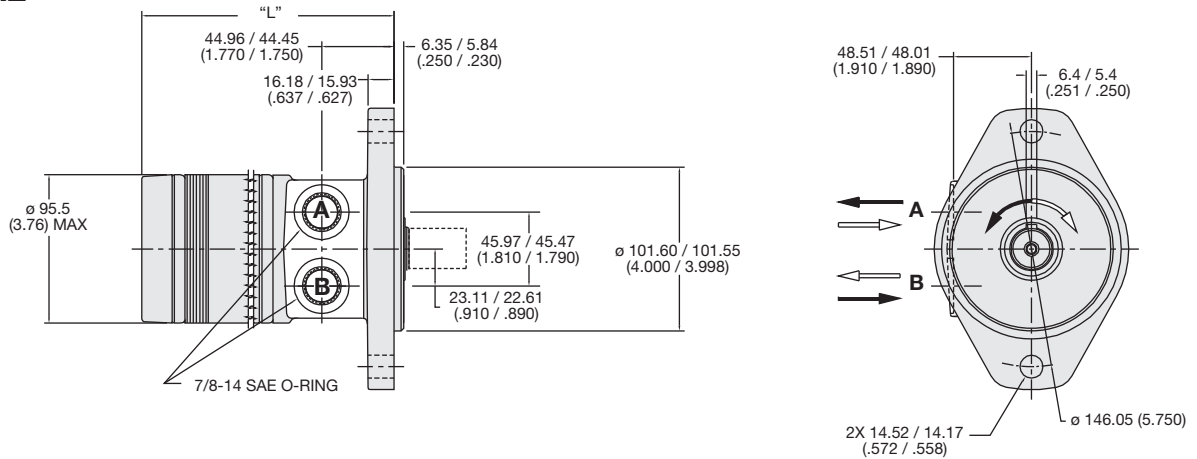

Code BS disp.	0036	0045	0050	0065	0080	0100	0130	0165	0195	0230	0260	0295	0330	0365	0390
Weight/Gewicht kg	7.27	7.34	7.48	7.62	7.71	7.84	8.11	8.39	8.70	8.93	9.16	9.43	9.70	9.97	10.1
Poids/Peso (lb)	(15.9)	(16.3)	(16.5)	(16.8)	(17.0)	(17.3)	(17.9)	(18.5)	(19.2)	(19.7)	(20.2)	(20.8)	(21.4)	(22.0)	(22.4)
Length "L" mm	131.5	132.5	134.1	137.1	140.4	143.5	149.8	156.2	162.5	168.9	175.2	181.6	187.9	196.5	200.9
"L" (in)	(5.18)	(5.22)	(5.28)	(5.40)	(5.53)	(5.65)	(5.90)	(6.15)	(6.40)	(6.65)	(6.90)	(7.15)	(7.40)	(7.74)	(7.91)

Code: CM
SAE A 2 Bolt, Long Pilot
5/16-18 UNC Manifold

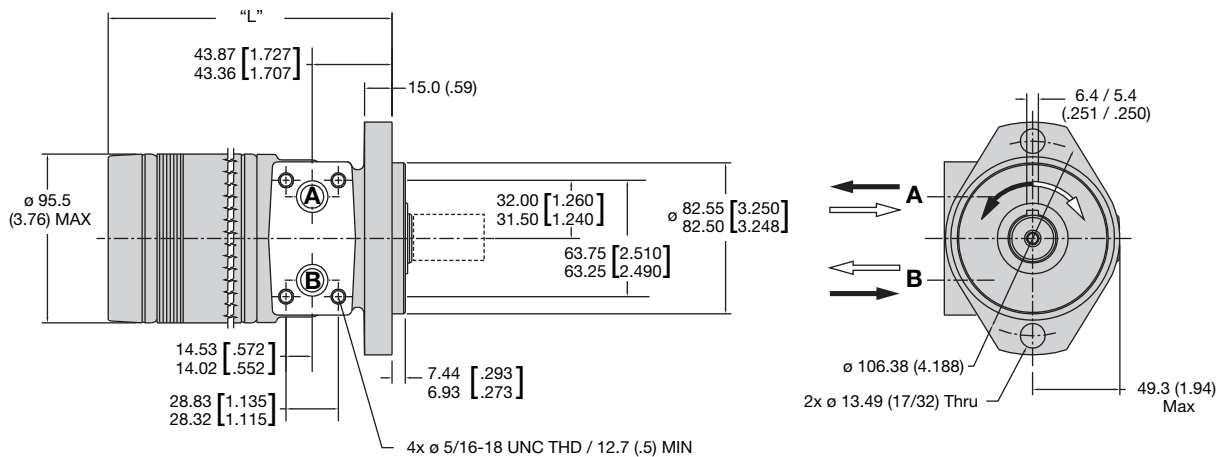

Code CM	disp.	0036	0045	0050	0065	0080	0100	0130	0165	0195	0230	0260	0295	0330	0365	0390
Weight/Gewicht kg	6.17	6.35	6.44	6.58	6.67	6.80	7.07	7.35	7.66	7.84	8.11	8.39	8.66	8.94	9.11	
Poids/Peso (lb)	(13.6)	(14.0)	(14.2)	(14.5)	(14.7)	(15.0)	(15.6)	(16.2)	(16.9)	(17.4)	(17.9)	(18.5)	(19.1)	(19.7)	(20.1)	
Length	"L" mm	130.4	131.5	132.9	136.1	139.3	142.5	148.8	155.2	161.5	167.9	174.2	180.6	186.9	195.6	199.7
"L" (in)		(5.13)	(5.18)	(5.23)	(5.36)	(5.48)	(5.61)	(5.86)	(6.11)	(6.36)	(6.61)	(6.86)	(7.11)	(7.36)	(7.70)	(7.86)

English equivalents for metric specifications are shown in ().

Code: MS
Magneto
7/8-14 SAE

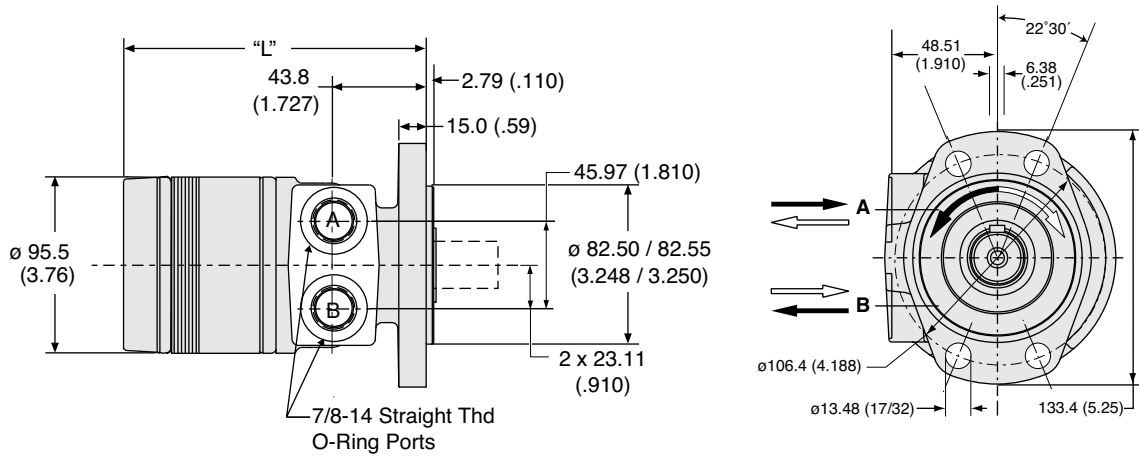

Code MS	disp.	0036	0045	0050	0065	0080	0100	0130	0165	0195	0230	0260	0295	0330	0365	0390
Weight/Gewicht	kg	6.16	6.30	6.40	6.53	6.62	6.76	7.03	7.30	7.62	7.85	8.12	8.35	8.62	8.94	9.07
Poids/Peso	(lb)	(13.6)	(13.9)	(14.1)	(14.4)	(14.6)	(14.9)	(15.5)	(16.1)	(16.8)	(17.3)	(17.9)	(18.4)	(19.0)	(19.7)	(20.0)
Length	"L" mm	135.1	136.1	137.6	140.8	144.0	147.1	153.5	159.8	166.2	172.5	178.9	185.2	191.6	200.2	204.3
	"L" (in)	(5.32)	(5.36)	(5.42)	(5.54)	(5.67)	(5.79)	(6.04)	(6.29)	(6.54)	(6.79)	(7.04)	(7.29)	(7.54)	(7.88)	(8.04)

Code: BP
SAE B 2-Bolt
1/2-14 NPTF

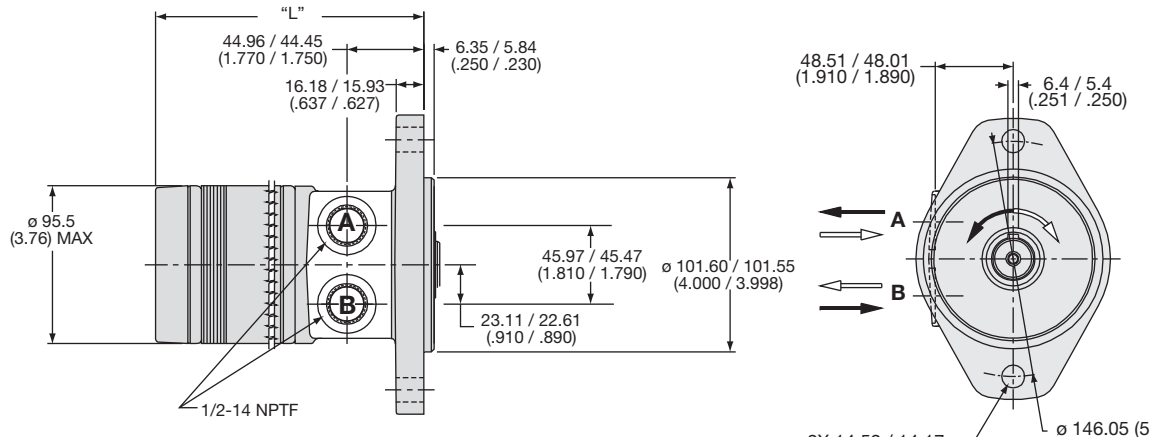

Code BP	disp.	0036	0045	0050	0065	0080	0100	0130	0165	0195	0230	0260	0295	0330	0365	0390
Weight/Gewicht	kg	7.27	7.34	7.48	7.62	7.71	7.84	8.11	8.39	8.70	8.93	9.16	9.43	9.70	9.97	10.1
Poids/Peso	(lb)	(15.9)	(16.3)	(16.5)	(16.8)	(17.0)	(17.3)	(17.9)	(18.5)	(19.2)	(19.7)	(20.2)	(20.8)	(21.4)	(22.0)	(22.4)
Length	"L" mm	131.4	132.5	134.0	137.2	140.4	143.6	149.9	156.3	162.6	169.0	175.3	181.7	188.0	196.7	200.8
	"L" (in)	(5.18)	(5.22)	(5.28)	(5.40)	(5.53)	(5.65)	(5.90)	(6.15)	(6.40)	(6.65)	(6.90)	(7.15)	(7.40)	(7.74)	(7.90)

English equivalents for metric specifications are shown in ().

Code: BM
SAE B 2-Bolt
5/16-18 UNC Manifold

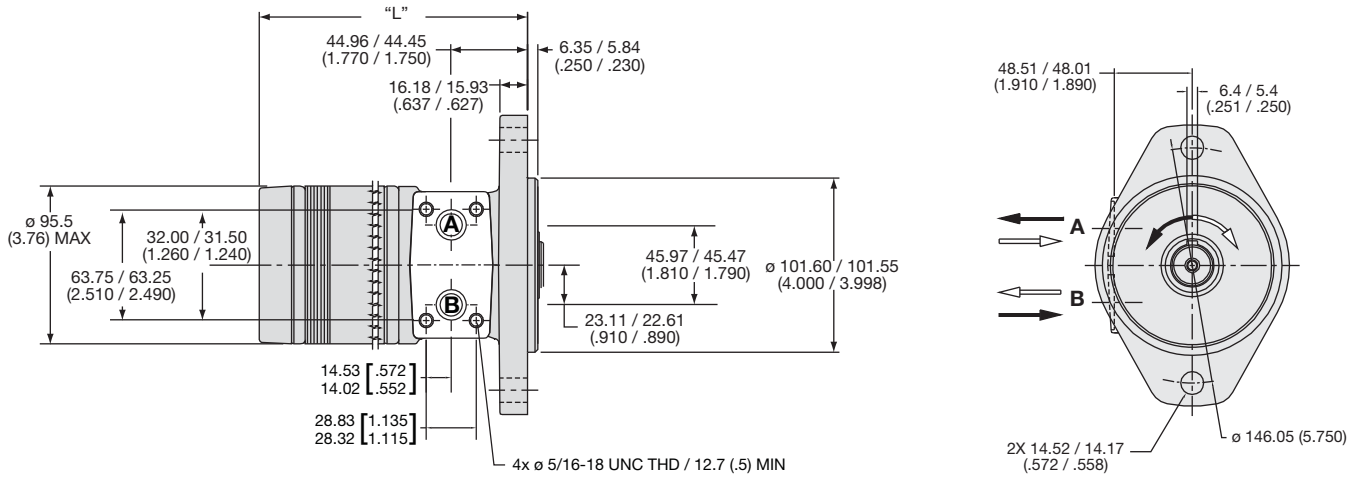

Code BM	disp.	0036	0045	0050	0065	0080	0100	0130	0165	0195	0230	0260	0295	0330	0365	0390
Weight/Gewicht	kg	7.27	7.34	7.48	7.62	7.71	7.84	8.11	8.39	8.70	8.93	9.16	9.43	9.70	9.97	10.1
Poids/Peso	(lb)	(15.9)	(16.3)	(16.5)	(16.8)	(17.0)	(17.3)	(17.9)	(18.5)	(19.2)	(19.7)	(20.2)	(20.8)	(21.4)	(22.0)	(22.4)
Length	"L" mm	131.4	132.5	134.0	137.2	140.4	143.6	149.9	156.3	162.6	169.0	175.3	181.7	188.0	196.7	200.8
	"L" (in)	(5.18)	(5.22)	(5.28)	(5.40)	(5.53)	(5.65)	(5.90)	(6.15)	(6.40)	(6.65)	(6.90)	(7.15)	(7.40)	(7.74)	(7.90)

Code: CP
SAE A 2 Bolt, Long Pilot
1/2-14 NPTF

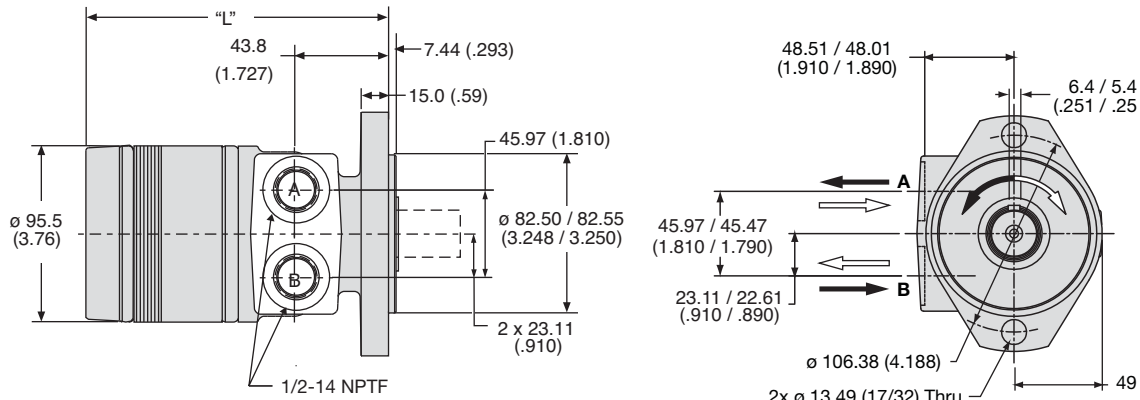

Code CP	disp.	0036	0045	0050	0065	0080	0100	0130	0165	0195	0230	0260	0295	0330	0365	0390
Weight/Gewicht	kg	6.17	6.35	6.44	6.58	6.67	6.80	7.07	7.35	7.66	7.84	8.11	8.39	8.66	8.94	9.11
Poids/Peso	(lb)	(13.6)	(14.0)	(14.2)	(14.5)	(14.7)	(15.0)	(15.6)	(16.2)	(16.9)	(17.4)	(17.9)	(18.5)	(19.1)	(19.7)	(20.1)
Length	"L" mm	130.4	131.5	132.9	136.1	139.3	142.5	148.8	155.2	161.5	167.9	174.2	180.6	186.9	195.6	199.7
	"L" (in)	(5.13)	(5.18)	(5.23)	(5.36)	(5.48)	(5.61)	(5.86)	(6.11)	(6.36)	(6.61)	(6.86)	(7.11)	(7.36)	(7.70)	(7.86)

English equivalents for metric specifications are shown in ().

Code: CS
SAE A 2 Bolt, Long Pilot
7/8-14 SAE

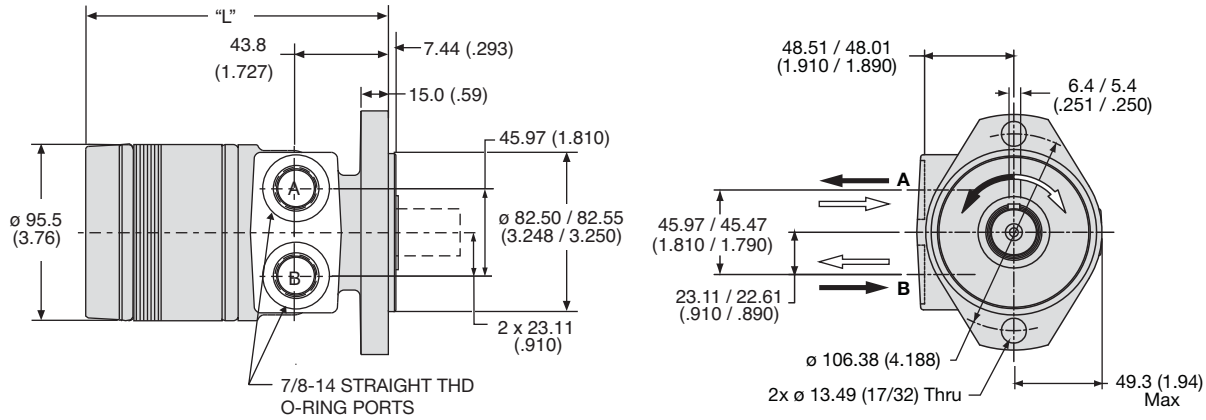

Code CS	disp.	0036	0045	0050	0065	0080	0100	0130	0165	0195	0230	0260	0295	0330	0365	0390
Weight/Gewicht	kg	6.17	6.35	6.44	6.58	6.67	6.80	7.07	7.35	7.66	7.84	8.11	8.39	8.66	8.94	9.11
Poids/Peso	(lb)	(13.6)	(14.0)	(14.2)	(14.5)	(14.7)	(15.0)	(15.6)	(16.2)	(16.9)	(17.4)	(17.9)	(18.5)	(19.1)	(19.7)	(20.1)
Length	"L" mm	130.4	131.5	132.9	136.1	139.3	142.5	148.8	155.2	161.5	167.9	174.2	180.6	186.9	195.6	199.7
	"L" (in)	(5.13)	(5.18)	(5.23)	(5.36)	(5.48)	(5.61)	(5.86)	(6.11)	(6.36)	(6.61)	(6.86)	(7.11)	(7.36)	(7.70)	(7.86)

Code: MM
Magneto
5/16-18 UNC Manifold

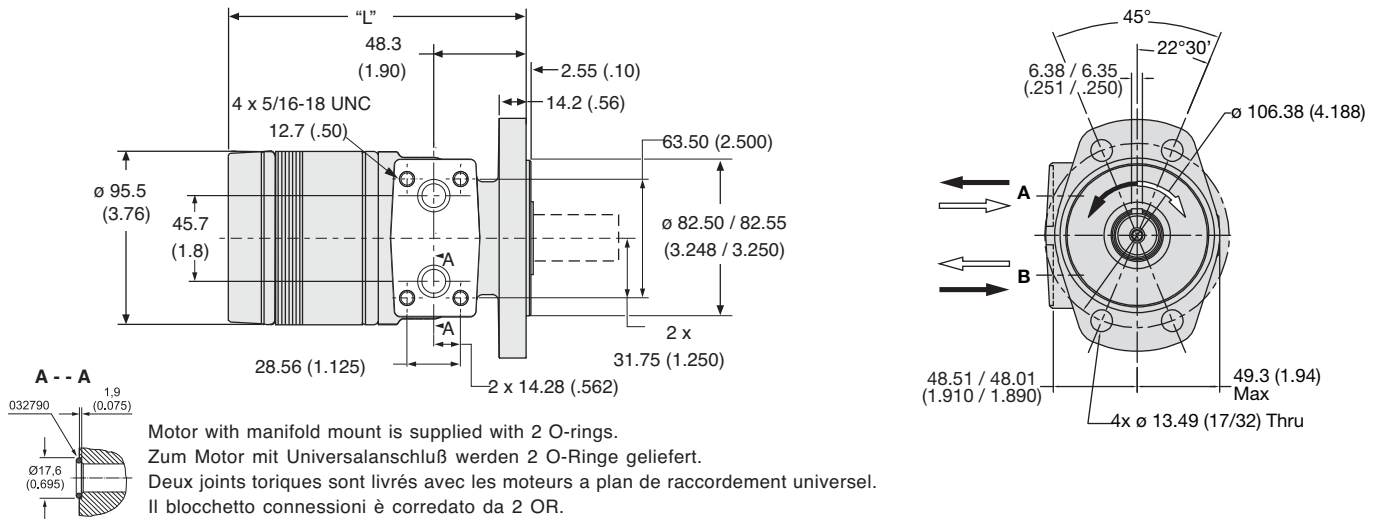

Code MM	disp.	0036	0045	0050	0065	0080	0100	0130	0165	0195	0230	0260	0295	0330	0365	0390
Weight/Gewicht	kg	6.16	6.30	6.40	6.53	6.62	6.76	7.03	7.30	7.62	7.85	8.12	8.35	8.62	8.94	9.07
Poids/Peso	(lb)	(13.6)	(13.9)	(14.1)	(14.4)	(14.6)	(14.9)	(15.5)	(16.1)	(16.8)	(17.3)	(17.9)	(18.4)	(19.0)	(19.7)	(20.0)
Length	"L" mm	135.0	136.1	137.6	140.8	144.0	147.1	153.5	159.8	166.2	172.5	178.9	185.2	191.6	200.2	204.3
	"L" (in)	(5.32)	(5.36)	(5.42)	(5.54)	(5.67)	(5.79)	(6.04)	(6.29)	(6.54)	(6.79)	(7.04)	(7.29)	(7.54)	(7.88)	(8.04)

English equivalents for metric specifications are shown in ().

Code: MP
Magneto
1/2-14 NPTF

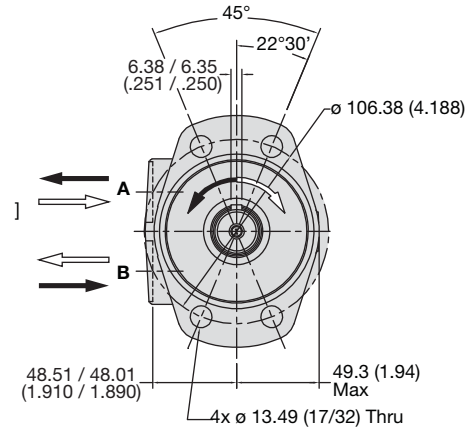
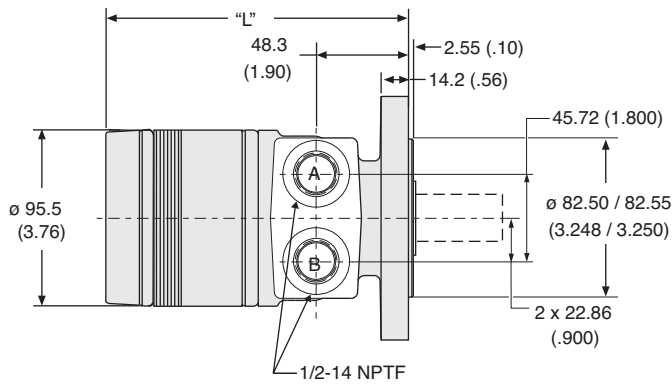

Code MP	disp.	0036	0045	0050	0065	0080	0100	0130	0165	0195	0230	0260	0295	0330	0365	0390
Weight/Gewicht	kg	6.16	6.30	6.40	6.53	6.62	6.76	7.03	7.30	7.62	7.85	8.12	8.35	8.62	8.94	9.07
Poids/Peso	(lb)	(13.6)	(13.9)	(14.1)	(14.4)	(14.6)	(14.9)	(15.5)	(16.1)	(16.8)	(17.3)	(17.9)	(18.4)	(19.0)	(19.7)	(20.0)
Length	"L" mm	135.1	136.1	137.6	140.8	144.0	147.1	153.5	159.8	166.2	172.5	178.9	185.2	191.6	200.2	204.3
	"L" (in)	(5.32)	(5.36)	(5.42)	(5.54)	(5.67)	(5.79)	(6.04)	(6.29)	(6.54)	(6.79)	(7.04)	(7.29)	(7.54)	(7.88)	(8.04)

English equivalents for metric specifications are shown in ().

002 TB.indd, js



Code: R
Rear Port
3/4"-16 SAE O-Ring

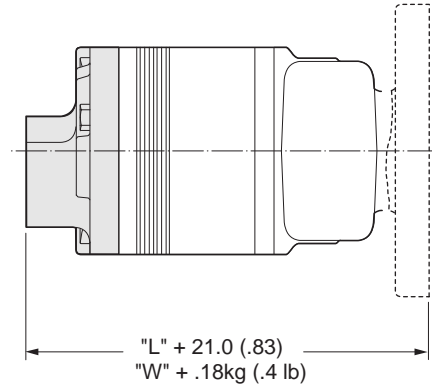
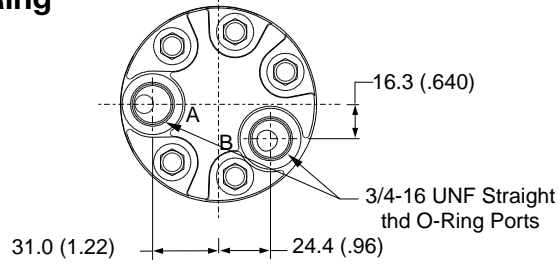

Code: Y
Rear Port
G 1/2 BSPP

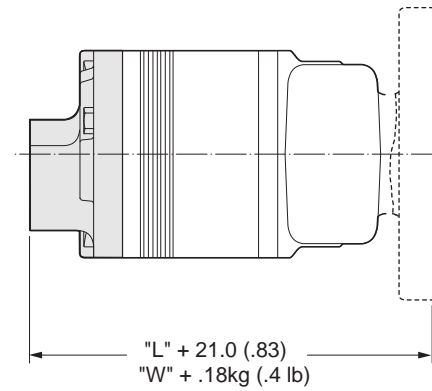
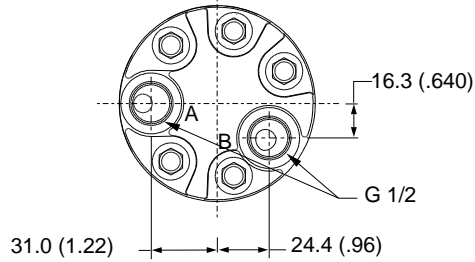

Code: S
7/8"-14 SAE O-Ring

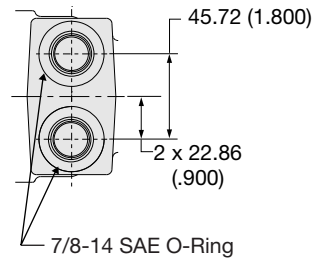

Code: P
1/2"-14 NPTF

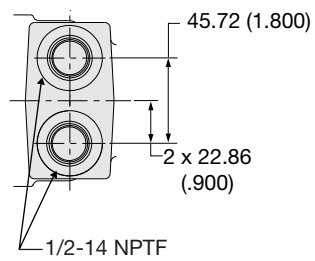

Code: M
Manifold

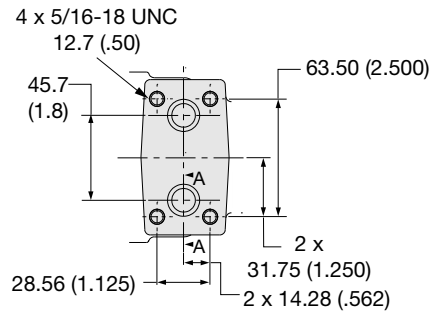

A - - A

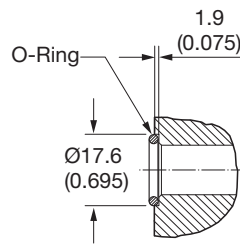

Motor with manifold mount is supplied with 2 o-rings (P/N 032790).

Zum Motor mit Universalanschluß werden 2 o-ringe geliefert.

Deux joints toriques sont livrés avec les moteurs a plan de raccordement universel.

Il blocchetto connessioni è corredato da 2 OR.

Code: W
G 1/2 BSPP
Milled Front

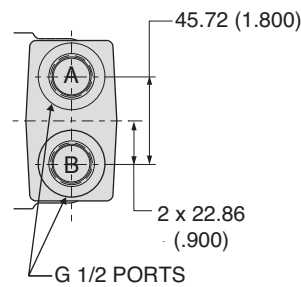

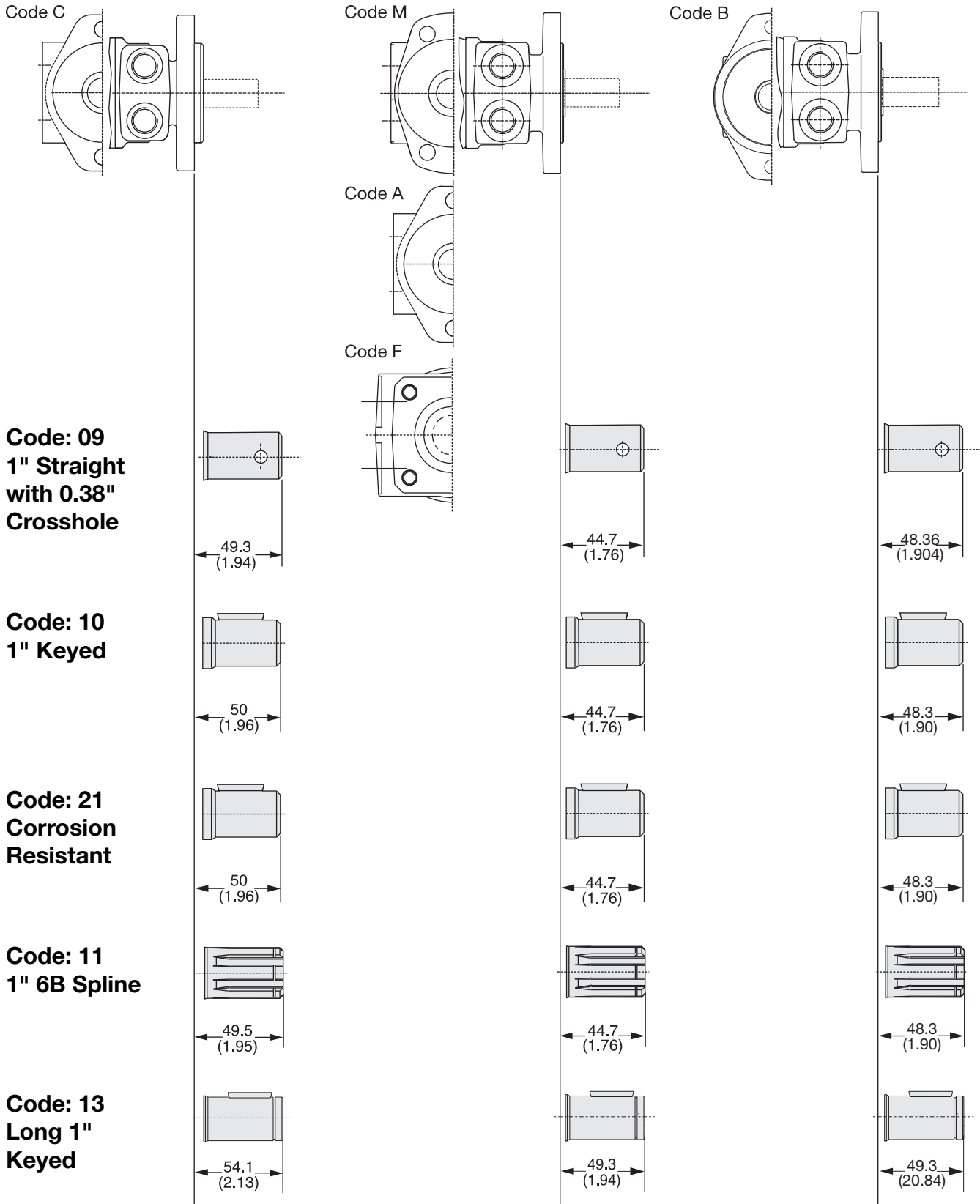

Code: 09
1" Straight
with 0.38"
Crosshole



Code: 10
1" Keyed

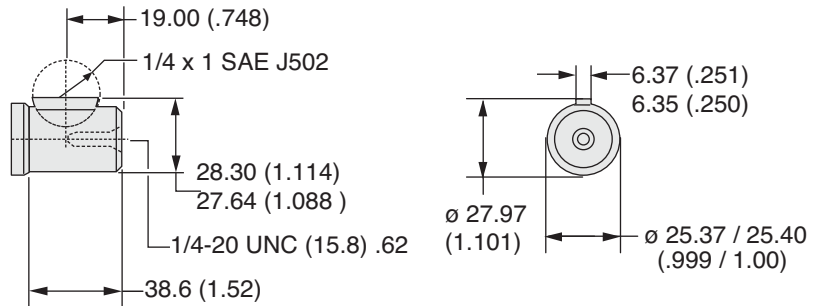

Code: 21
Corrosion
Resistant

Code: 11
1" 6B Spline

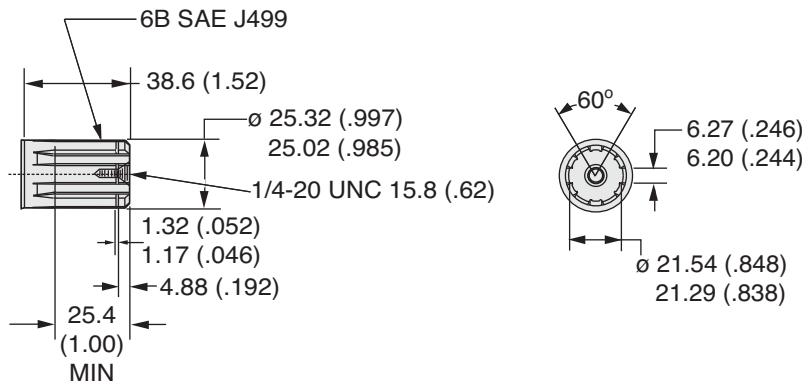

Code: 13
Long 1"
Keyed

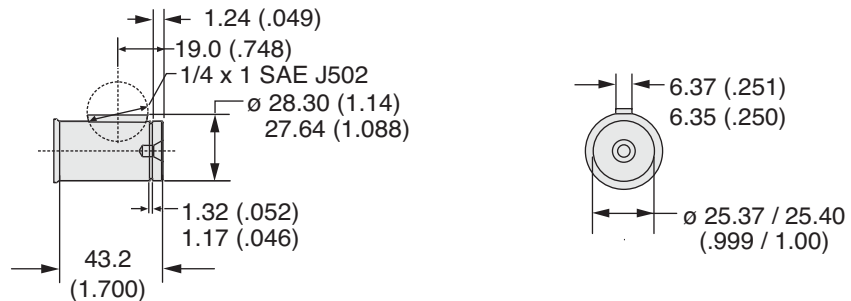

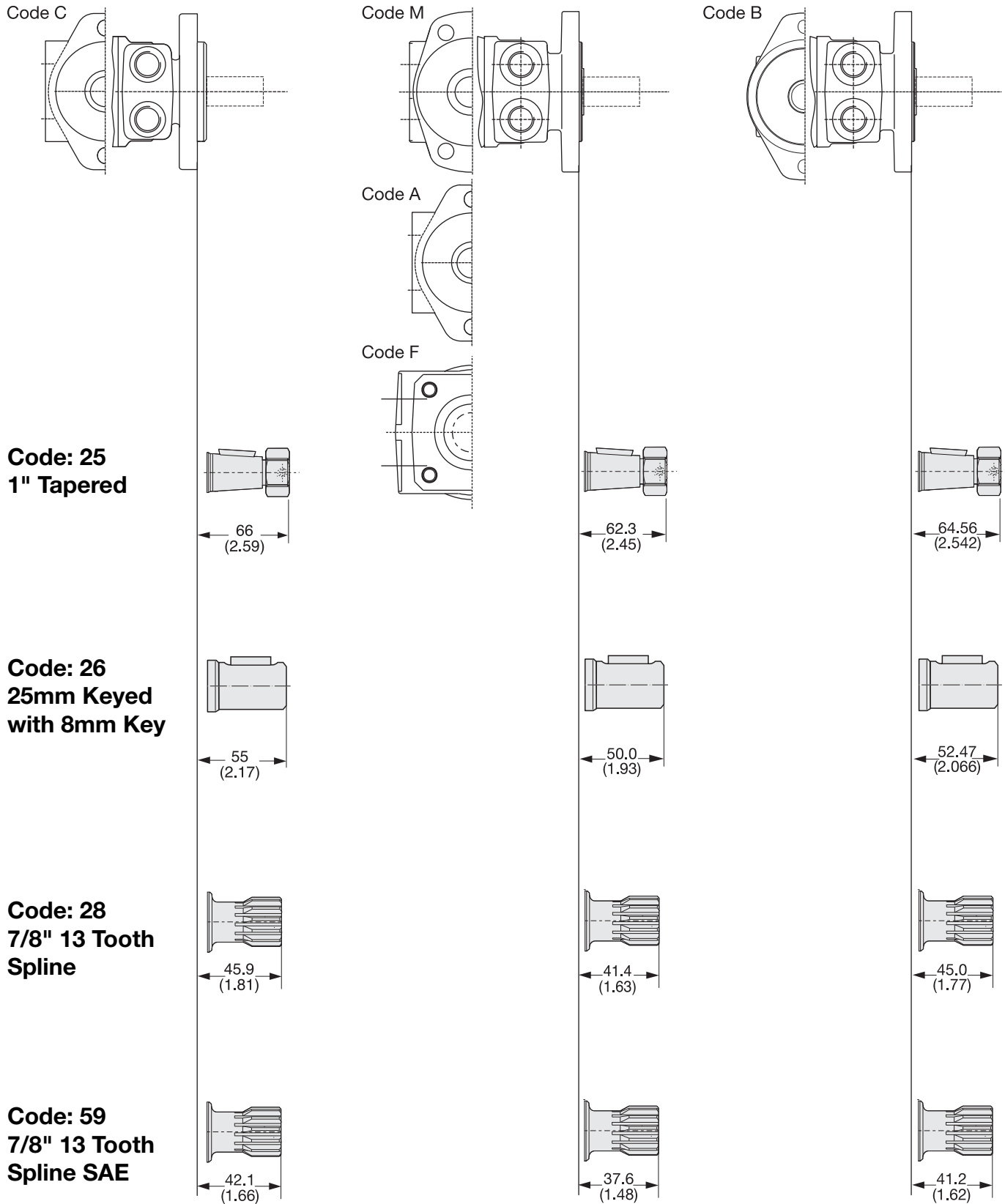

Code: 25
1" Tapered

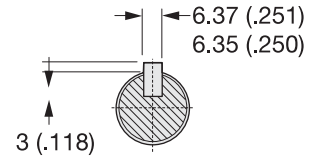
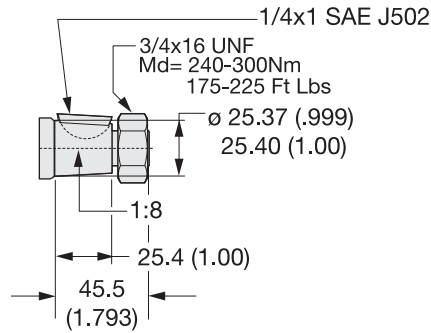

Code: 26
25mm Keyed
with 8mm Key

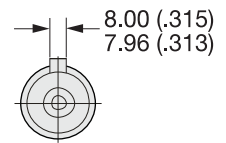
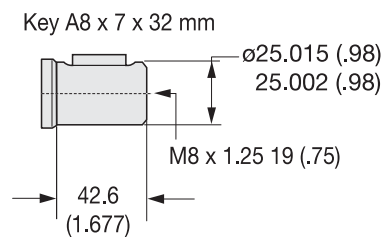

Code: 28
7/8" 13 Tooth
Spline

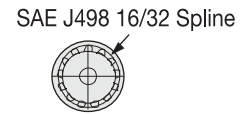
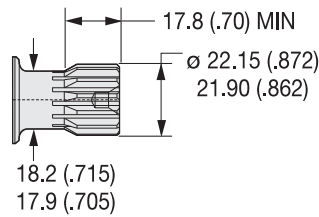

Code: 59
7/8" 13 Tooth
Spline SAE

